



Nilfisk



Kornmarksvej 1 | DK-2605 Broendby | Denmark | Tel.: (+45) 4323 8100

Neo - Instructions for use**Caution: Read the instructions before using the machine**

Safety Instructions



Before first use of the machine, read the instructions carefully. Save instructions for later use.

Warnings

⚠ Do not use the machine without dust bag and filters properly fitted. ⚠ This machine is not intended for the suction of hazardous materials or gas, doing so may expose people to serious health risks. ⚠ The machine must not be used for the suction of water or other liquids. ⚠ Do not pick up sharp objects such as needles or pieces of glass. ⚠ Do not pick up anything that is burning or smoking such as cigarettes, matches or hot ashes. ⚠ Use and store this machine indoors and in a dry environment, 0 °C to 60 °C. ⚠ Do not use the machine outdoors. ⚠ When activating the automatic cable rewind, care must be taken as the plug at the end of the electric cable can swing during the last part of the rewinding. It is recommended that you hold on to the plug while rewinding. ⚠ Do not handle the machine with wet hands. ⚠ Turn off the machine before unplugging. ⚠ To unplug, grasp the plug, not by pulling on the electric cable. Do not carry or pull the machine by the electric cable. ⚠ The machine must not be used if the electric cable shows any sign of damage. Regularly inspect the electric cable for damage, in particular if it has been crushed, shut in a door or run over. ⚠ Do not use the machine if it appears faulty. Have the machine inspected by an authorized service centre if the machine has been dropped, damaged, left outdoors or has been exposed to water. ⚠ No changes or modifications to the mechanical or electrical safety devices should be made. ⚠ All repair must be carried out by an authorized service centre. ⚠ Use only original dust bags, original filters and original accessories from your local dealer. Use of unauthorized dust bags and filters will void the warranty. ⚠ Turn off the machine and unplug before starting dust bag or filter change, grasp the plug, not by pulling on the electric cable. ⚠ If the supply elec-

tric cable is damaged, it must be replaced by the manufacturer, its service agent or similarly qualified persons in order to avoid a hazard. ⚠ Do not touch rotating parts by hand when using turbo nozzle.

⚠ This appliance can be used by children aged from 8 years and above and persons with reduced physical, sensory or mental capabilities or lack of experience and knowledge if they have been given supervision or instruction concerning use of the appliance in a safe way and understand the hazards involved. ⚠ Do not allow children to clean the appliance or perform user maintenance without supervision. ⚠ Children must be supervised to make sure that they do not play with the appliance. ⚠ Do not charge non-rechargeable batteries. ⚠ Remove rechargeable batteries from the appliance before charging. ⚠ Do not mix different types of batteries or new and used batteries. ⚠ Pay attention to the correct polarity when inserting batteries. ⚠ Remove exhausted batteries from the appliance and dispose of them safely. ⚠ If the appliance is to be stored unused for a long period, remove the batteries. ⚠ Do not short-circuit the supply terminals.

Service and maintenance

Store the machine indoors and in a dry environment. ● Change the pre-filter with every fourth dust bag. ● Clean the machine surface with a dry cloth or a damp cloth with a little cleaning agent. ● Order original accessories from a local dealer. ● For service, contact your local dealer.

Responsibility

Nilfisk disclaims all responsibility for all damage caused by incorrect use or modification of the machine. Please refer to our website at www.consumer.nilfisk.com for further instructions and information on use.

WEEE

The symbol  indicates that this appliance may not be discarded together with household waste, but must be collected separately. Please dispose old appliances at the applicable collection point for recycling.

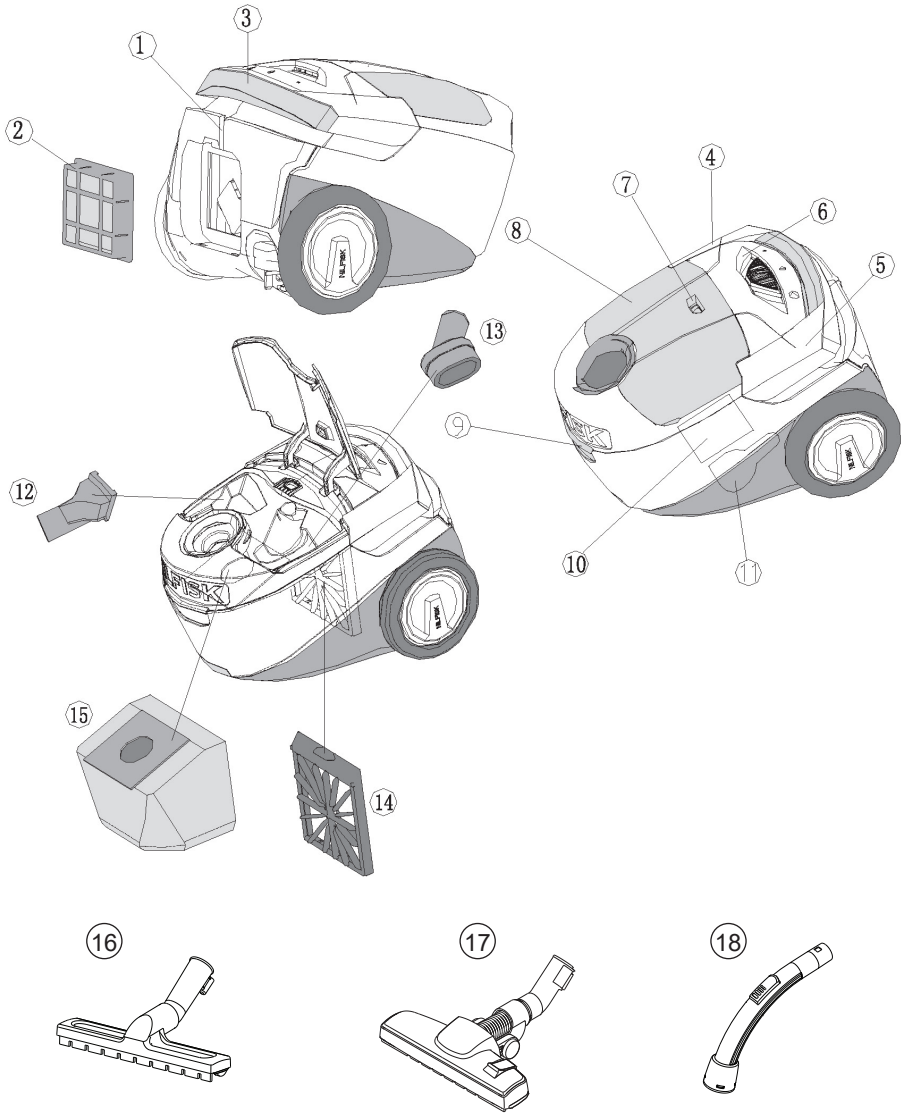

The different models of the vacuum cleaners can include different nozzles

Overview

- 1 Parking bracket
- 2 HEPA filter
- 3 Handle
- 4 Cable rewriter
- 5 On/off button
- 6 Power level
- 7 Dust bag indicator, mechanical
- 8 Accessory lid
- 9 Open/close button, dust container
- 10 Rating plate
- 11 Parking bracket
- 12 Upholstery nozzle
- 13 Brush nozzle
- 14 Prefilter
- 15 Dust bag
- 16 Hard floor nozzle
- 17 Combination nozzle
- 18 Sliding valve

Display symbols on handle



The dust bag is full and needs to be changed when the indicator is completely red.

Specifications and details are subject to change without prior notice.

Instructions for use

Before using the machine make sure that the voltage shown on the rating plate underneath the machine corresponds with the mains voltage.

The machine is supplied with dust bag and pre-filter.

Numbers **1** refer to illustrations.

Start and stop

Start

Pull out the electric cable and plug the machine to a wall socket.

On/off button and power level.

Stop

Turn off the machine and unplug. Unplug by grasping the plug, not by pulling on the electric cable.

1 Connecting hose, tube and nozzles

1. Insert the hose connector into the suction inlet.
2. Connect the bent tube to the tube.
3. Connect the tube to the nozzle.
4. The tube is telescopic and can be adjusted to your height. Push the adjusting button to extend the tube, and pull back to shorten to desired length.

Change of dust bag and filters

The size and quality of the dust bag and filters affect the machine efficiency. Use of non original dust bags or non original filters can cause restricted air flow which may lead to machine overload. Using non-original dust bag or filters will void the warranty.

2 Changing the dust bag

The dust bag indicator turns completely red when the dust bag needs to be changed. Always use original dust bags.

3 Changing the pre-filter

The pre-filter protects the motor by absorbing micro-particles that the dust bag cannot keep. Change the pre-filter with every fifth dust bag. The pre-filter is located behind the dust bag. Always use original filters.

4 Changing the HEPA filter

The HEPA filter cleans the exhaust air from micro particles the dust bag can not keep. The HEPA filter cannot be brushed or washed clean if not mentioned.

Washable HEPA filter

Some models have washable HEPA filter.

Rinse the inside of the filter using lukewarm tap water. Do not use any cleaning agents and avoid touching the filter surface. Tap the filter frame to remove the water. Do not use an external heat source, e.g. a radiator or direct sunlight to dry the filter.

Make sure to let the filter dry before putting it back into the vacuum cleaner.

Adjust the suction power

Sliding valve on the bent tube

The suction power is maximal with the sliding valve closed and minimal when all open. Adjust the suction power by putting the sliding valve in the desired position.

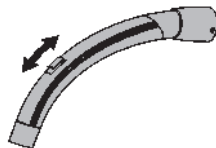

Power regulation

The suction power is adjusted with slider on the machine.



Tip: Adjust smaller suction power to reduce noise and pull force.

5 Parking the tube and nozzle

There are two grooves for parking. One located on the underside of the machine to use when machine stands on the back. The other on the back of the machine, to be used when the machine is standing on its wheels.

Thermal fuse

The machine is fitted with a thermal fuse, which prevents the machine from overheating. If the thermal fuse blows, the machine automatically switches off the motor and must cool before it can be started again.

Restart

1. Turn off the machine and unplug from the wall socket.
2. Ensure that nothing blocks the air flow through hose handle, hose, tube, nozzle, dust bag or filters.
3. Let the machine cool.
4. Plug in the machine again and push start button. The machine will not start until cool enough. If the machine does not start, turn it off and unplug. Try again in a while.

Cleaning tips

Adjust the suction power by means of the power regulation or the sliding valve on the bent tube.

6 Upholstery nozzle

Use the upholstery nozzle for upholstered furniture.

7 Brush nozzle

Use the brush nozzle for curtains and window sills.

8 Hard floor nozzle

Use the nozzle for hard floors.

9 Combination nozzle

Adjust the combination nozzle depending on type of floor.

10 Turbo nozzle

Use the turbo nozzle for efficient carpet cleaning.

The upholstery and brush nozzles are located under the accessory lid. The accessory lid is opened by pressing the release button downwards. The lid is closed manually.

The different models of these vacuum cleaners can include different nozzles.

Trouble shooting

Repair or service of electrical components as electric cable or motor, must only be carried out by an authorized service center.

If the machine does not start	See to that the plug is correctly fitted to the wall socket.
	A fuse in the building may have blown and needs to be changed.
	The electric cable or plug can be damaged and must be repaired by an authorized service center.
Reduced suction power	The dust bag can be full and needs to be changed, see instructions.
	The pre-filter or the HEPA filter can be blocked and have to be changed, see instructions.
	The hose handle, hose, tube or nozzle can be blocked and needs to be cleaned.
If the machine stops	The thermal fuse may have blown, see instructions.

Service and maintenance

- Store the machine indoors and in a dry environment.
- Change the pre-filter with every fourth dust bag. The dust bag package includes five dust bags and one pre-filter.
- Clean the machine surface with a dry cloth or a damp cloth with a little cleaning agent.
- Order original accessories from a local dealer.
- Service – contact your local dealer.

Recycling and scrapping

Recycle the wrapping and scrap the machine and the electric cable according to recommendations from the local authorities.

Cut the electric cable as short as possible to avoid that someone gets injured on the scrapped machine.

Environmental commitment

This machine is designed with the environment in mind. All plastic parts can be used for recycling.

Responsibility

Nilfisk disclaims all responsibility for all damage caused by incorrect use or modification of the machine.

Information

For more information see www.nilfisk.com

Guarantee and service

This Nilfisk Neo Series vacuum cleaner is covered by a two (2) year guarantee on the machine, which covers the motor, cable rewinder, switch and casing. The nozzles, filters, hoses, tubes and other accessories are covered twelve months due to manufacturing fault only and excludes wear and tear.

The guarantee includes spare parts and labour costs, and covers manufacturing and material defects that may occur during normal domestic use.

Service under the guarantee will only be performed if it can be proven that the defect occurred within the product's guarantee period (a correctly completed guarantee certificate or printed/stamped cash register receipt with date and product type) and on the condition that the vacuum cleaner was bought as a new product and distributed by Nilfisk.

In the event of the repair of defects, the customer must contact Nilfisk to be directed to a service agent at the customers own expense. Upon completion of any repairs necessary, the vacuum cleaner will be returned to the customer at the risk and expense of Nilfisk.

The guarantee does not cover:

- normal wear and tear of accessories and filters
- defects or damage occurring as a direct or indirect result of incorrect use - such as the vacuuming of rubble, hot ashes or carpet deodorant powder
- abuse, loss or lack of maintenance as described in Instructions for use
- plaster dust
- saw dust
- water
- if the machine has been used for home renovations

Nor will it cover incorrect or poor configuration, i.e. setting up or connection, nor fire-damage, fire, lightning strike or unusual voltage fluctuations or any other electrical disturbances such as defective fuses or defective electrical installations on the supply grid, and defects or damage in general that Nilfisk consider to be the result of causes other than manufacturing and material defects.

The guarantee becomes void:

- if a defect is caused by the use of non-original Nilfisk dust bags and filters
- if the identity number is removed from the vacuum cleaner
- if the vacuum cleaner has been repaired by a non-Nilfisk authorized dealer
- if the machine is used in a commercial environment, i.e. building contractors, cleaning contractors, professional trades or any other non-domestic usage

Addendum Australia

Our goods come with guarantees that cannot be excluded under the Australian Consumer Law. You are entitled to a replacement or refund for a major failure and for compensation for any other reasonably foreseeable loss or damage. You are also entitled to have the goods repaired or replaced if the goods fail to be of acceptable quality and the failure does not amount to a major failure.

Nilfisk vacuum cleaners for domestic use are warranted for 2 years from the date of purchase by:

Nilfisk Pty Ltd
Unit 1/13 Bessemer Street
Blacktown NSW 2148
Phone: 1300 556 710
E-mail: sales@nilfisk.com.au

Find your local service agent here:

<http://www.nilfisk.com.au>.

The benefits under this warranty are in addition to your national law of sale.

1

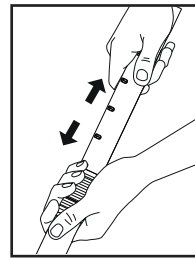
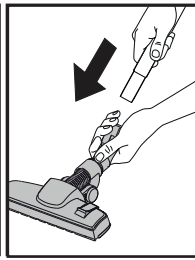
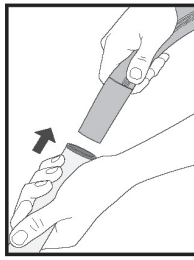
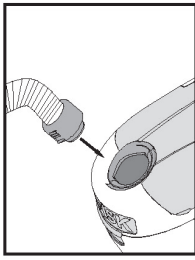

2

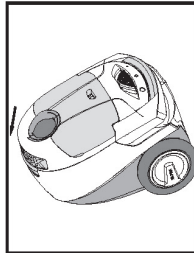
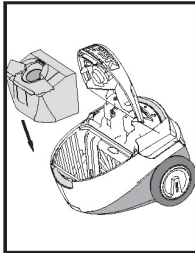
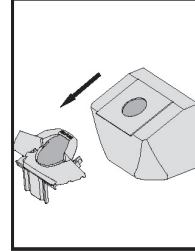
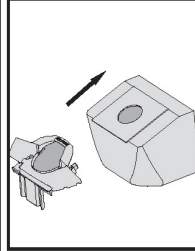
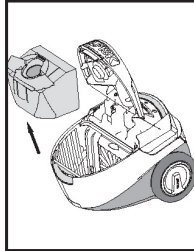
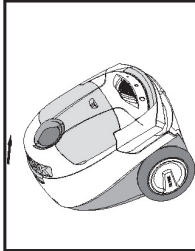

3

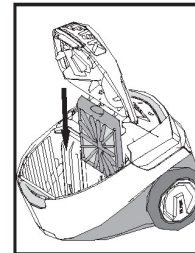
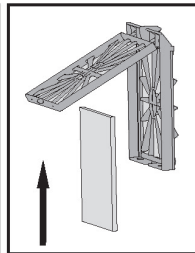
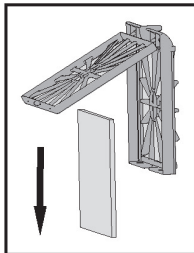
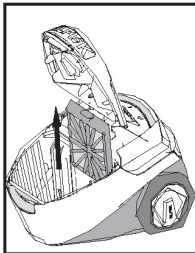

4

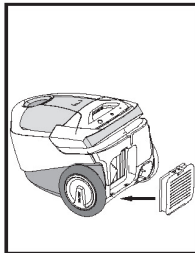
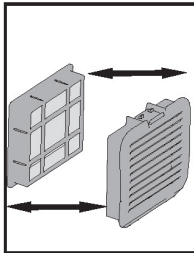
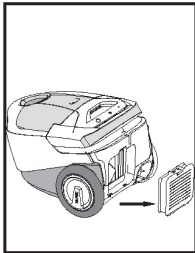

5

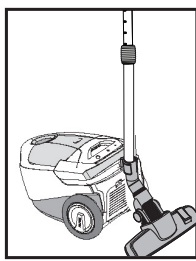
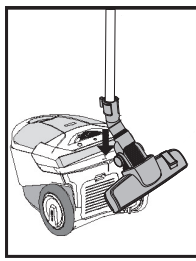
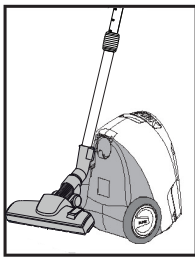
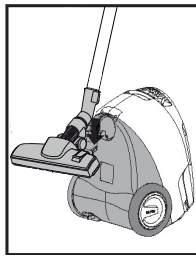

6

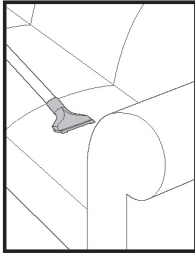
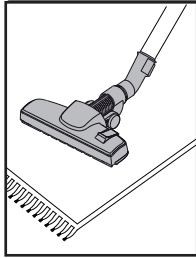

7

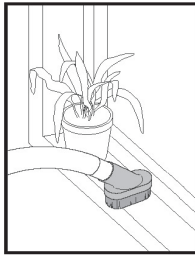
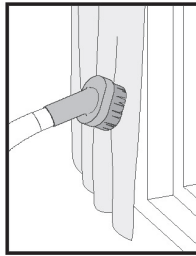

8

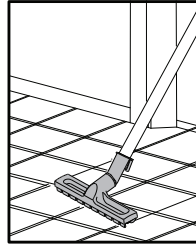

9

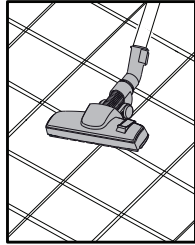

10

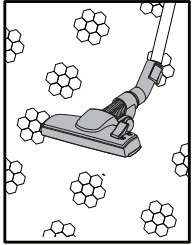

HEAD QUARTER

DENMARK

Nilfisk A/S

Kornmarksvej 1

DK-2605 Brøndby

Tel.: (+45) 4323 8100

Website: www.nilfisk.com

SALES COMPANIES

AUSTRALIA

Nilfisk Pty Ltd

1/13 Bessemer Street

Blacktown NSW 2148

Tel.: 1300 556 710

Website: www.nilfisk.com.au

NEW ZEALAND

Nilfisk Limited

Suite F, Building E

42 Tawa Drive

0632 Albany Auckland

Tel.: (+64) 9 414 1996

Website: www.nilfisk.com