



# One

















## Kasutusjuhend















# Ohutusjuhised

-  Enne masina esmakordset kasutamist tuleb see kasutusjuhend hoolikalt läbi lugeda. Salvestage juhtnõõrid edaspidiseks kasutamiseks.
- 

## Hoiatused !

-  Ärge kasutage masinat ilma tolmu- ja õigesti paigaldatud filtriteta.
-  See masin ei ole mõeldud ohtlike materjalide või gaasi imemiseks, kuna see võib põhjustada inimestele tõsiseid terviseriske.
-  Masinat ei tohi kasutada vee või muude vedelike imemiseks.
-  Ärge tõstke üles teravaid esemeid, nagu nõelad või klaasitükid.
-  Ärge tõstke üles midagi, mis põleb või suitseb, näiteks sigarette, tikke või kuuma tuhka.
-  Kasutage ja hoidke masinat siseruumides ja kuivas keskkonnas, temperatuuril 0 °C kuni 60 °C.
-  Ärge kasutage masinat väljas.
-  Kaabli automaatse tagasikerimise aktiveerimisel peab olema ettevaatlik, sest pistik elektri-juhtme otsas võib tagasikerimise lõpus kõikuda. Soovitav on tagasikerimise ajal pistikust kinni hoida.
-  Ärge käsitsege masinat märgade kätega.
-  Lülitage masin enne vooluvõrgust lahutamist välja.
-  Vooluvõrgust lahutamiseks võtke kinni pistikust, mitte juhtmest. Ärge kandke ega tõmmake masinat juhtmest.
-  Masinat ei tohi kasutada, kui juhtmel on märke kahjustustest. Kontrollige regulaarselt juhete kahjustuste suhtes, eriti juhul, kui see on saanud muljuda, jäänud ukse vahele või sellest on üle sõidetud.
-  Ärge kasutage masinat, kui see näib vigane. Laske masinat kontrollida volitatud teeninduskeskuses, kui masin on maha kukkunud, kahjustatud, olnud välitingimustes või puutunud kokku veega.
-  Mehaanilisi ega elektriohutuse seadmeid ei tohiks muuta ega modifitseerida.
-  Kõik parandustööd peab tegema selleks volitatud teeninduskeskus.
-  Kasutage ainult oma kohalikult edasimüüjalt ostetud originaaltolmu- ja õigesti paigaldatud filtriteta, originaalfiltreid ja originaaltarvikuid. Heakskiitmata tolmu- ja õigesti paigaldatud filtrite kasutamine muudab garantii kehtetuks.

-  Lülitage masin enne tolmu- ja õigesti paigaldatud filtriteta vahetamisega alustamist välja ja lahutage vooluvõrgust. Võtke kinni pistikust, mitte ärge tõmmake juhtmest.
-  Kui toitejuhe saab viga, peab tootja, tootja hooldustehnik või sarnase kvalifikatsiooniga isik selle ohu vältimiseks välja vahetama.
-  Ärge puudutage turbootsaku kasutamisel pöörlevaid osi käega.
-  Seda seadet saavad kasutada lapsed alates 8. eluaastast ning vähenenud füüsilise, sensoorse või vaimse võimekusega või kogemusteta inimesed, kui neid jälgitakse või juhendatakse, kuidas kasutada seadet ohutult ja kui nad kaasnevatest ohtudest aru saavad.
-  Ärge lubage lastel seadet puhastada või teha kasutajapoolset hooldust ilma järelevalveta.
-  Lapsi tuleb juhendada, et veenduda, et nad seadmega ei mängiks.
-  Ärge laadige mittelaetavaid patareisid.
-  Eemaldage taaslaetavad patareisid seadmest enne laadimist.
-  Ärge kasutage koos eri tüüpi patareisid või uusi ja kasutatud patareisid.
-  Jälgige patareide sisestamisel õiget polaarsust.
-  Eemaldage tühjad patareisid seadmest ja kõrvaldage need ohutult.
-  Kui seadet tuleb hoida kasutamata pikema aja jooksul, eemaldage sellest patareisid.
-  Ärge lühistage toitetermine.

## Teenindus ja hooldus

Hoidke masinat siseruumides ja kuivas keskkonnas.

- Vahetage eelfiltrit koos iga neljanda tolmu- ja õigesti paigaldatud filtriteta.
- Puhastage masina pinda kuiva või veidi niiske lapi ja väikese koguse puhastusvahendiga.
- Tellige originaaltarvikuid kohalikult edasimüüjalt.
- Hoolduseks võtke ühendust kohaliku edasimüüjaga.

## Vastutus

Nilfisk ütleb lahti kogu vastutusest kahjustuste eest, mille on põhjustanud vale kasutamine või masina muutmise. Täpsemaid juhtnõõre ja teavet kasutamise kohta vt meie veebilehelt [www.nilfisk.com](http://www.nilfisk.com).

## WEEE



Sümbol  näitab, et seda seadet ei tohi ära visata koos olmejäätmetega, vaid tuleb koguda eraldi. Viisake vanad seadmed taastöötuseks ära vastavas kogumispunktis.

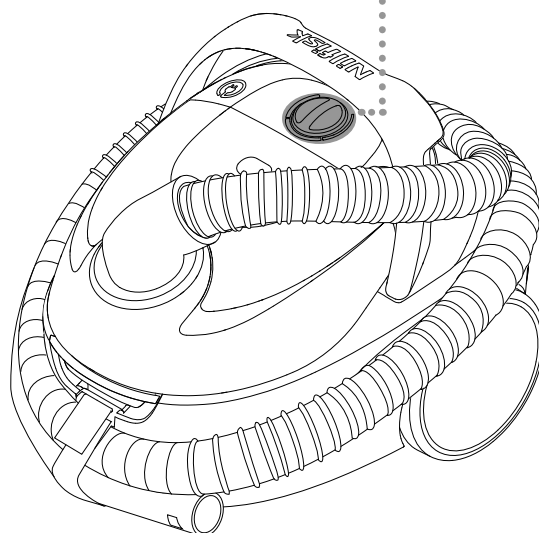
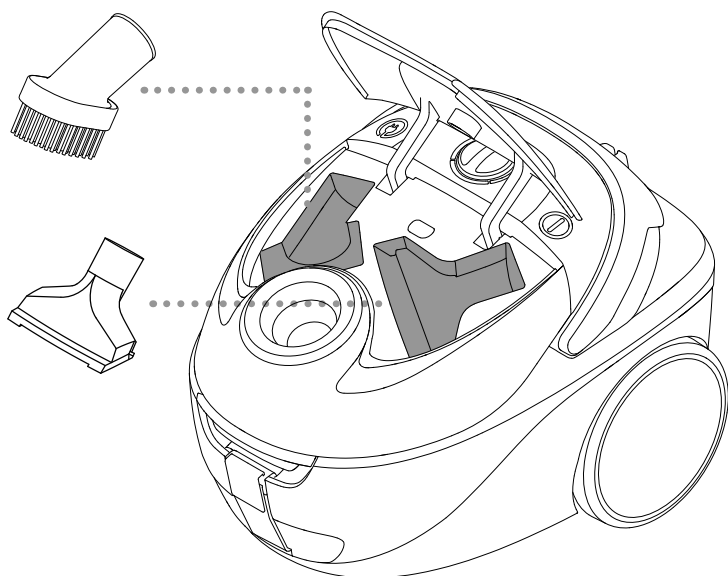
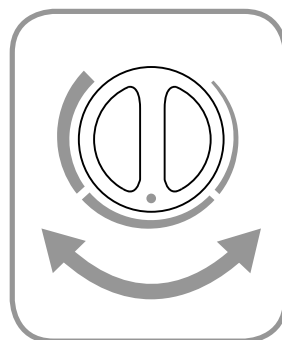
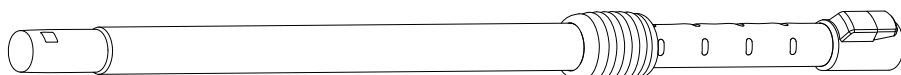
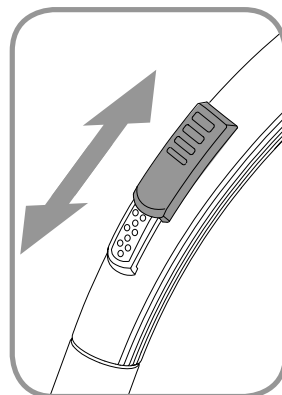
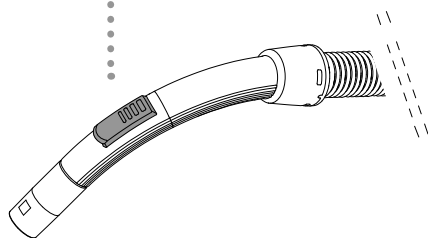
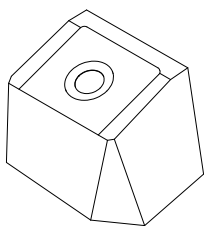
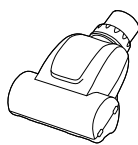
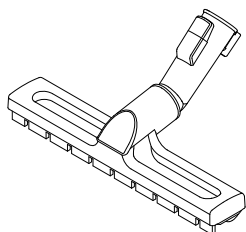
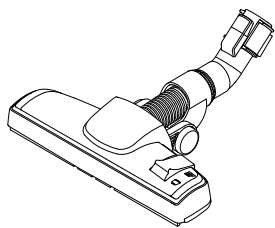

Mudelitel võivad standardvarustuses olla erinevad otsikud.

A 

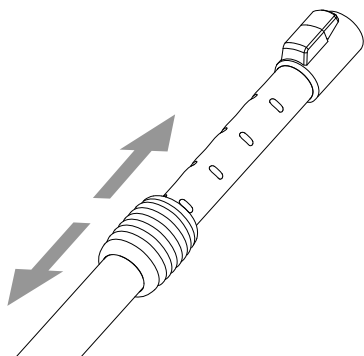
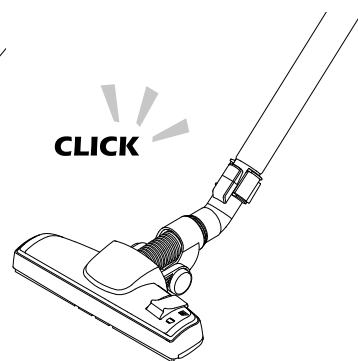
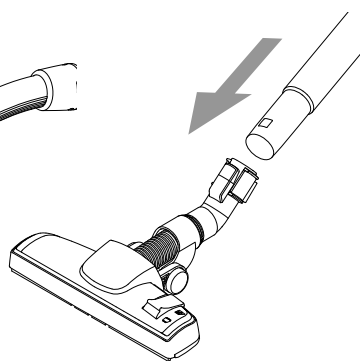
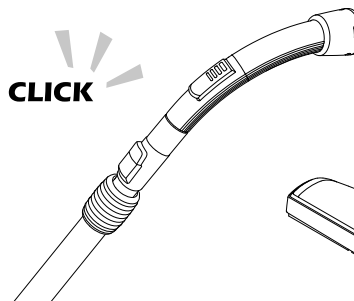
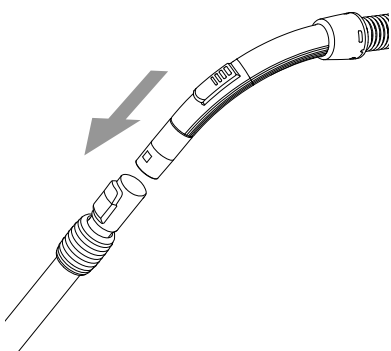
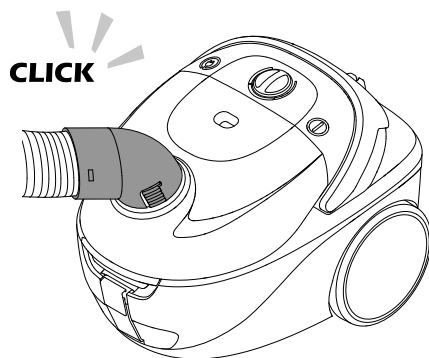
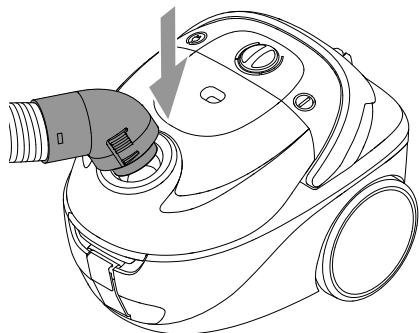

B 

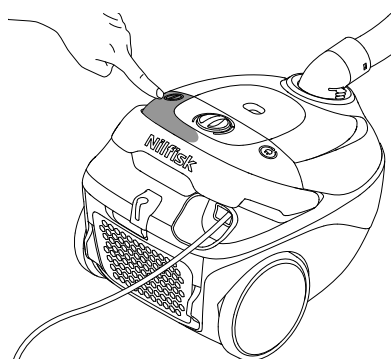
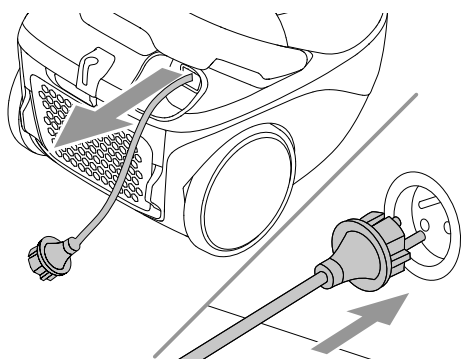

C 

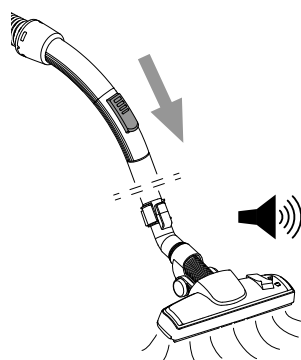
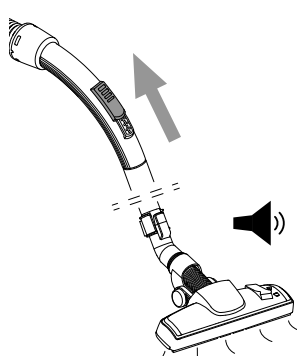
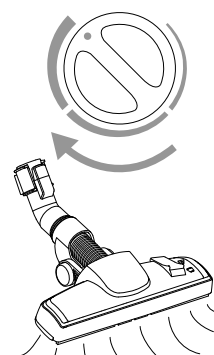
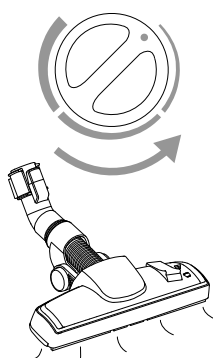
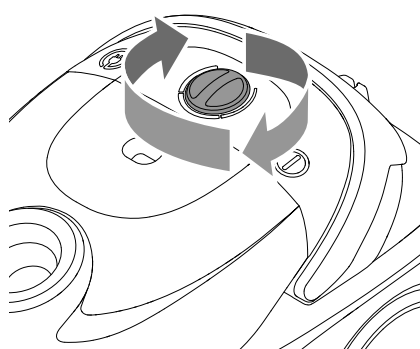

D 

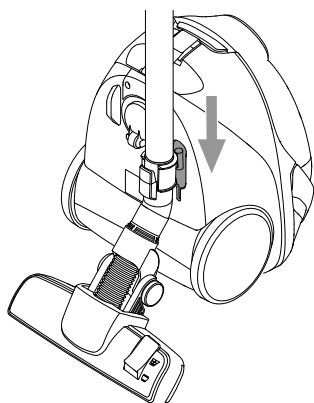
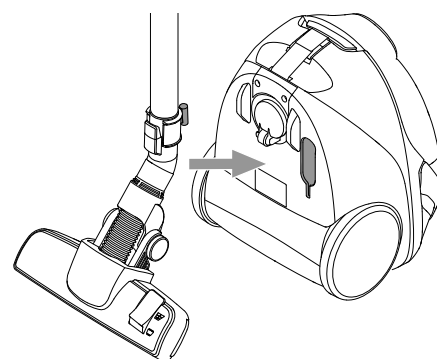
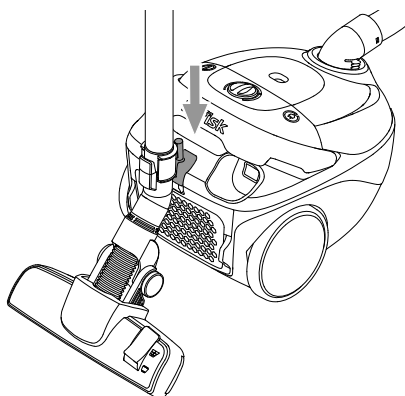
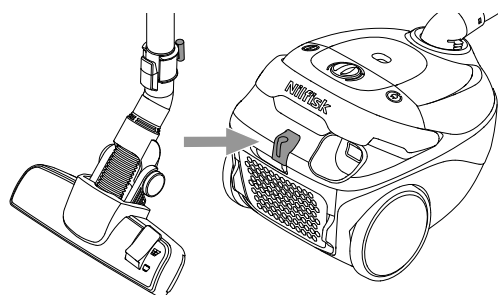

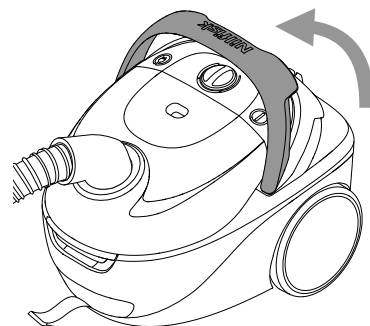
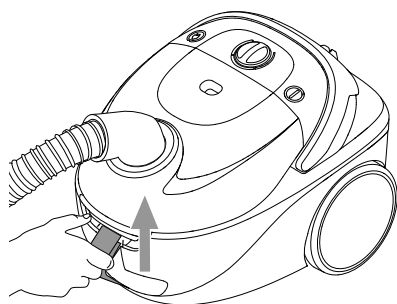
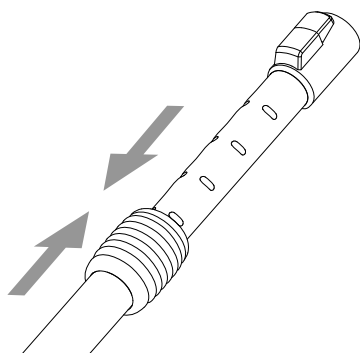
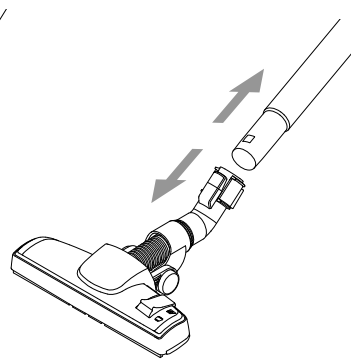
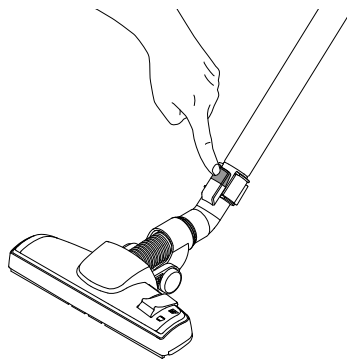
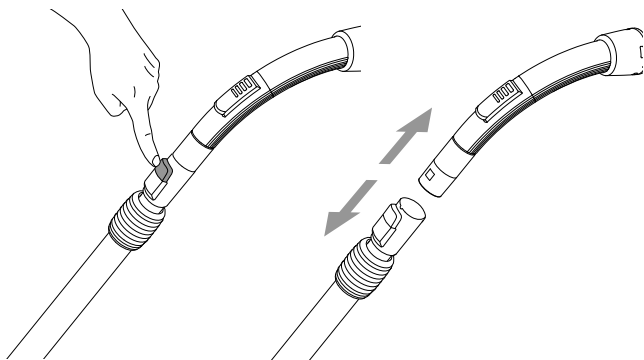
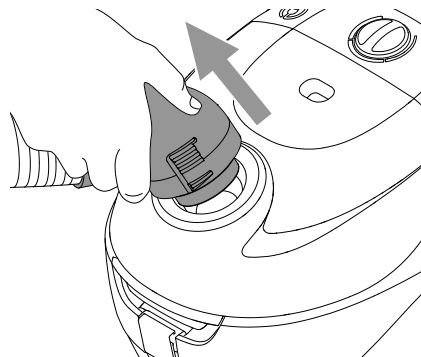
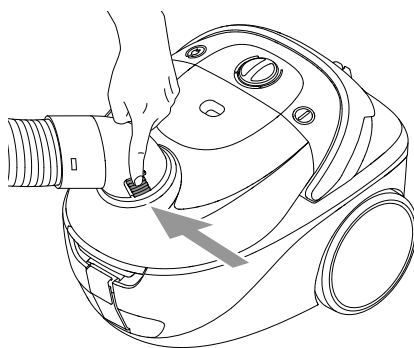
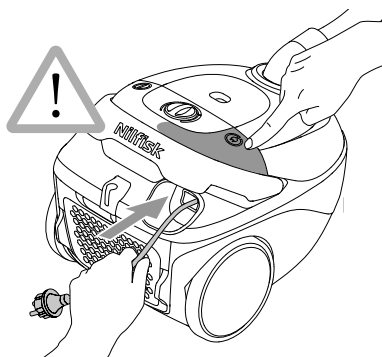
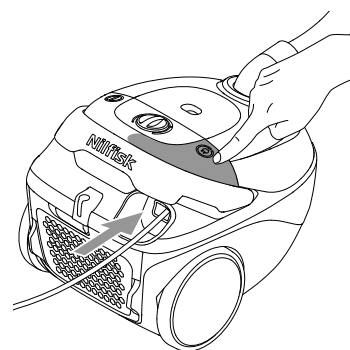
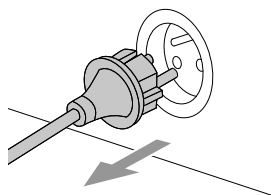
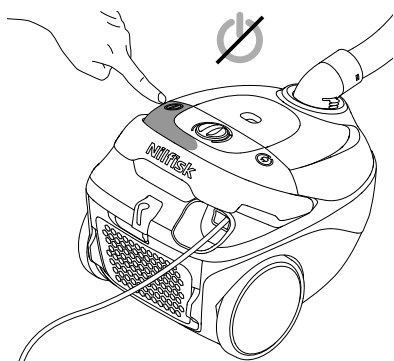

E

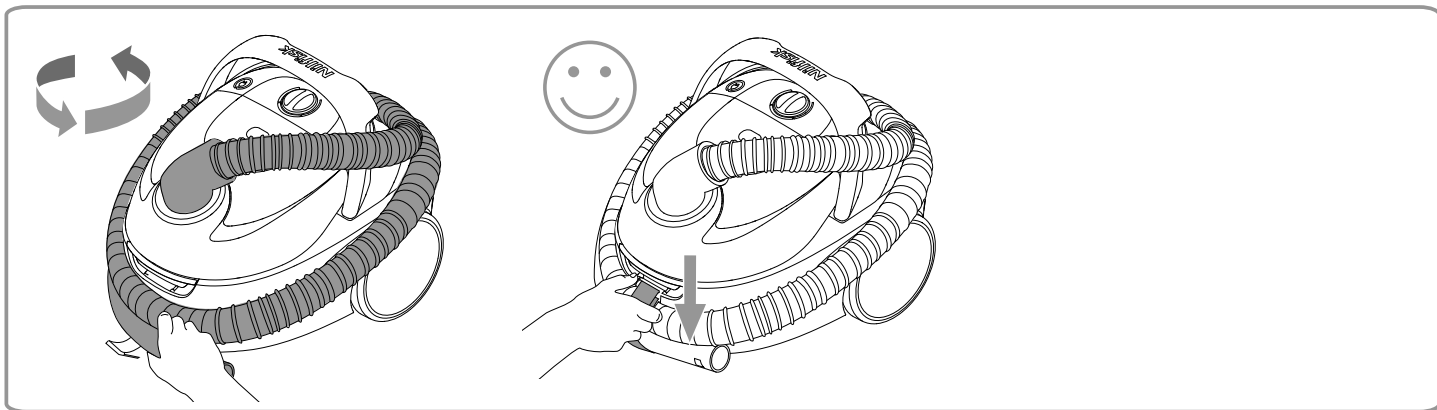

F

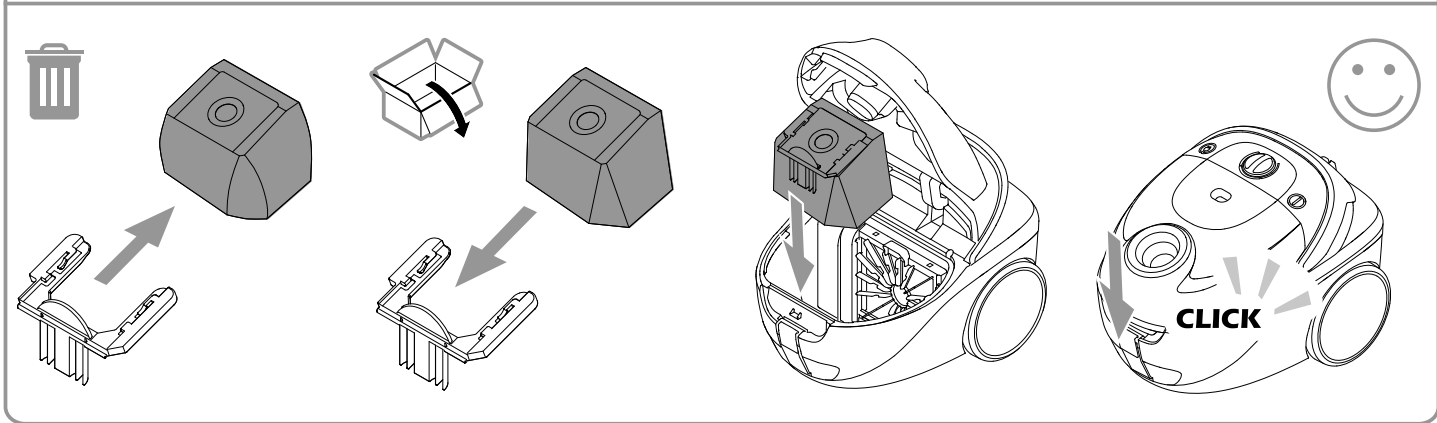
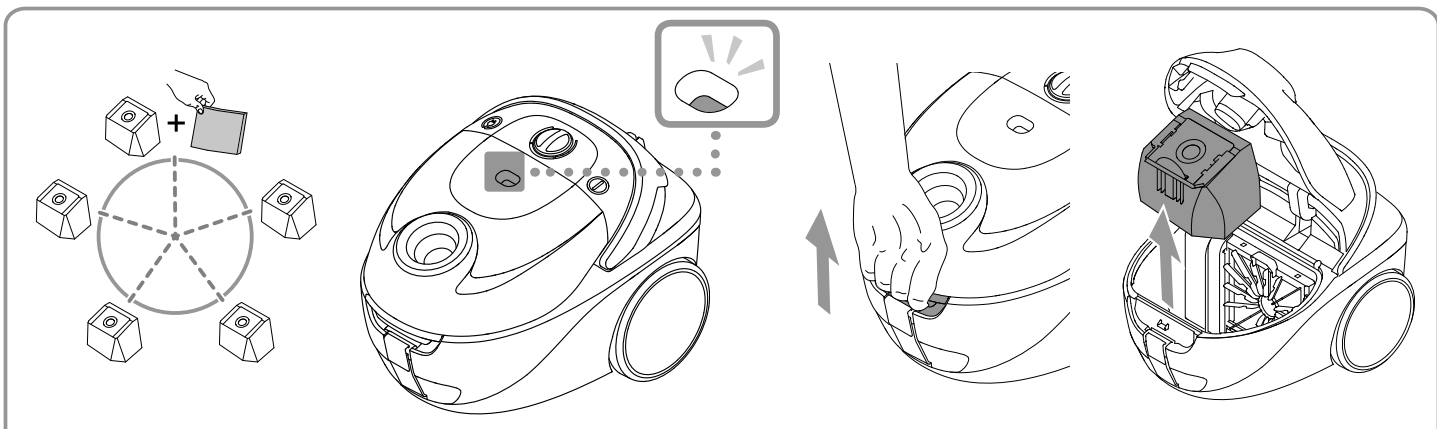

G

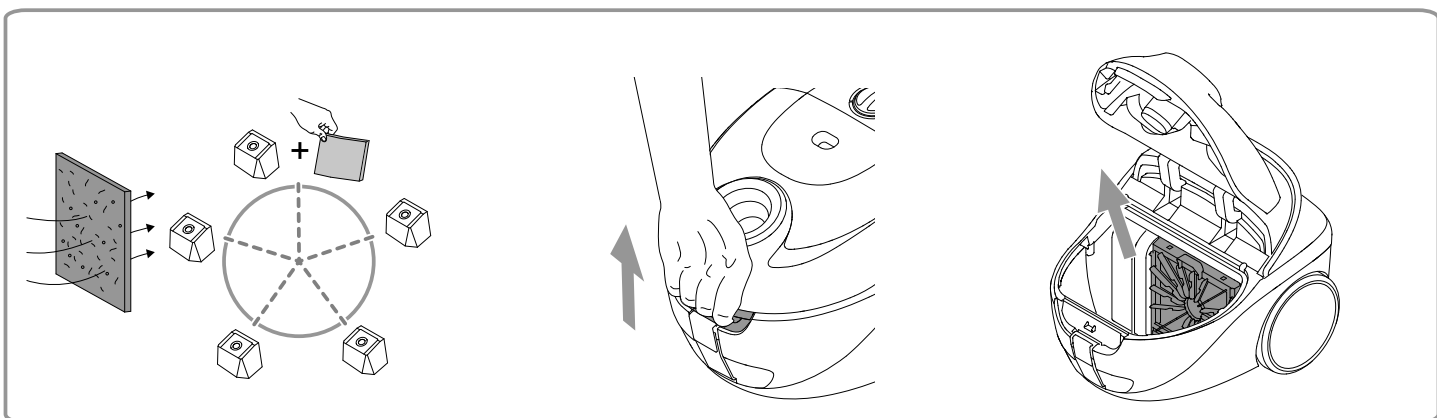

G

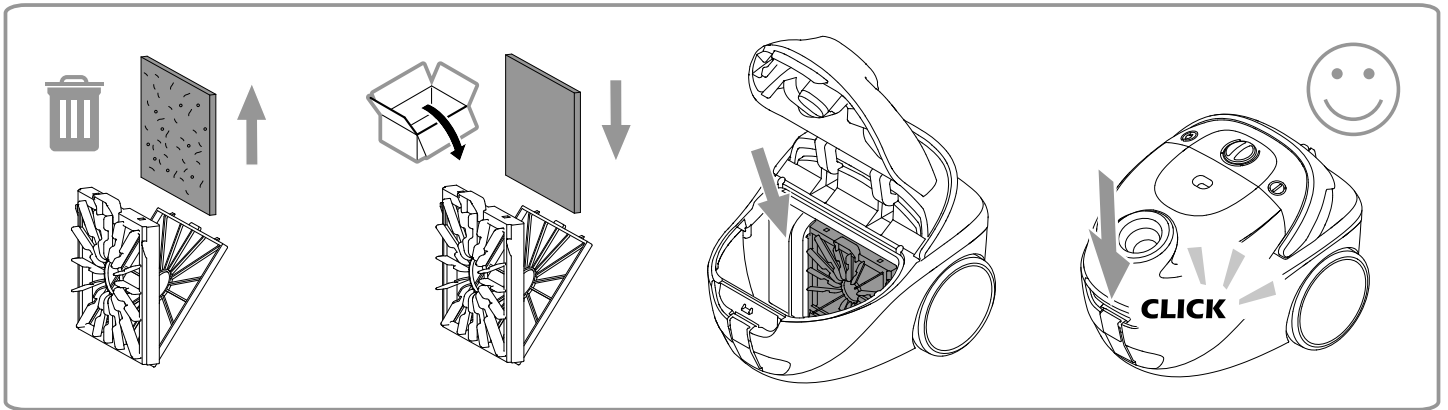

H

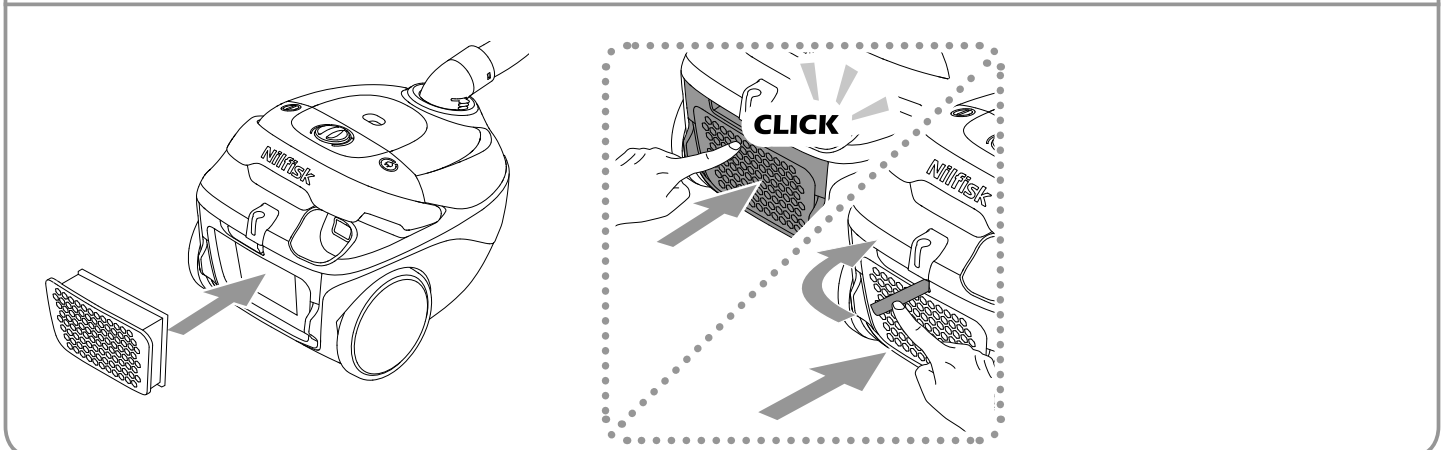
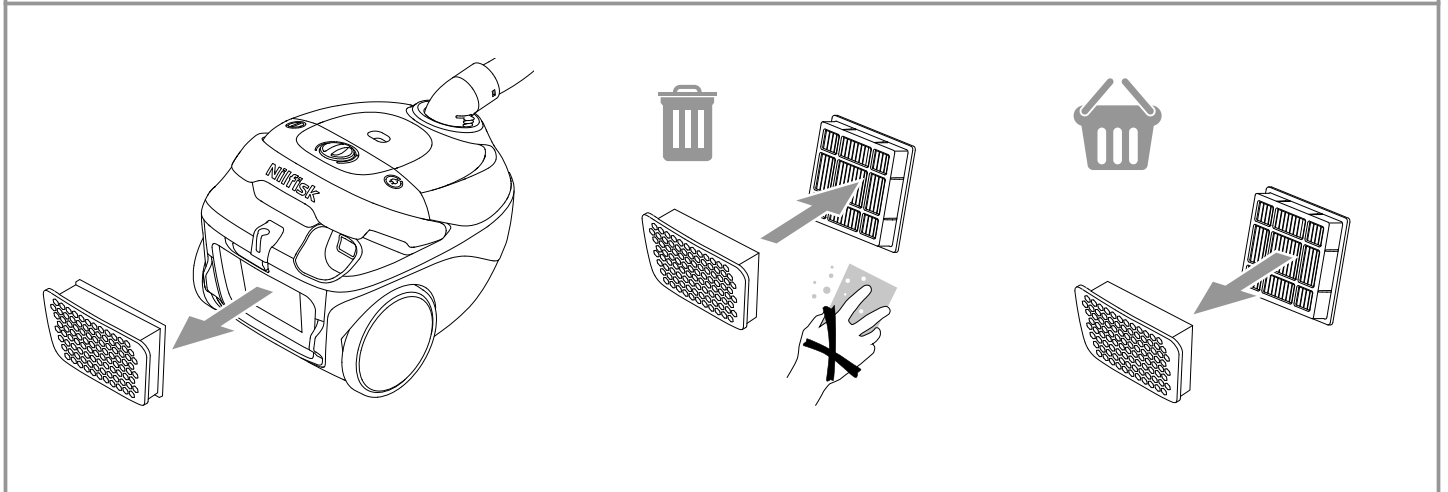
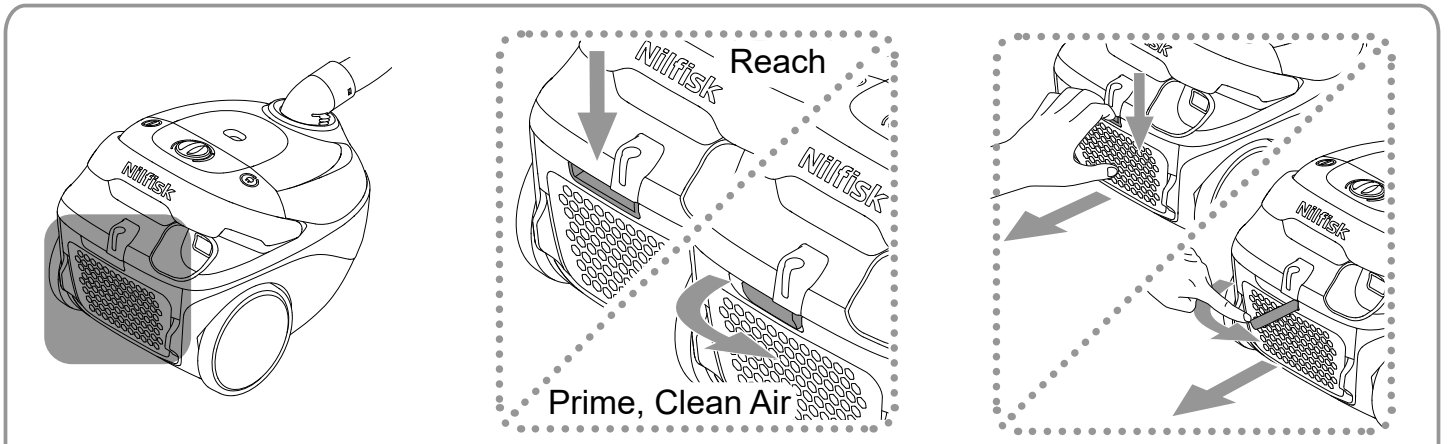

I 

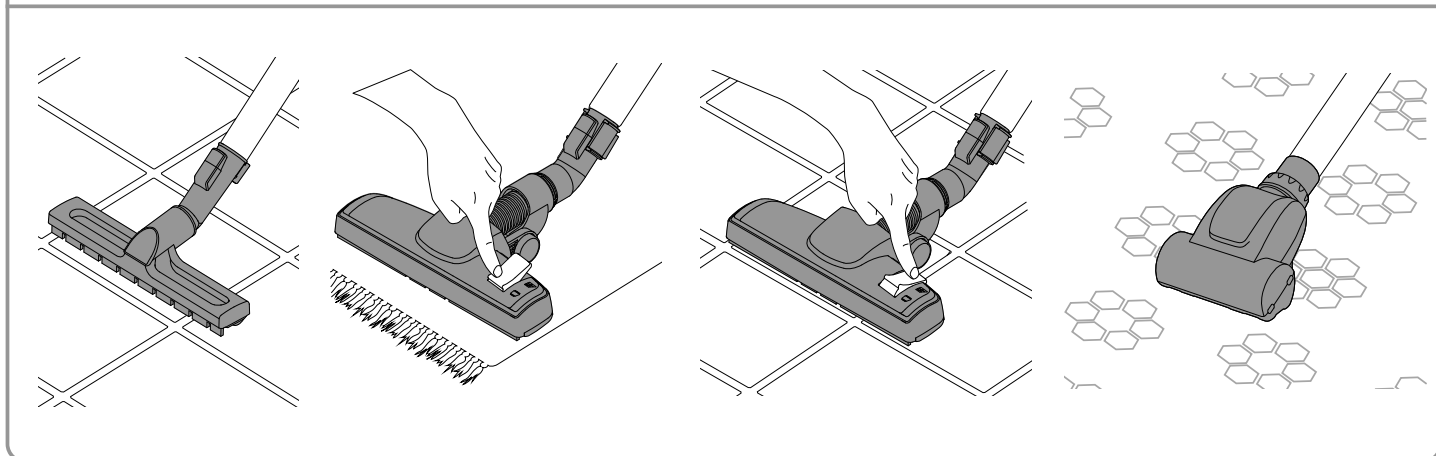
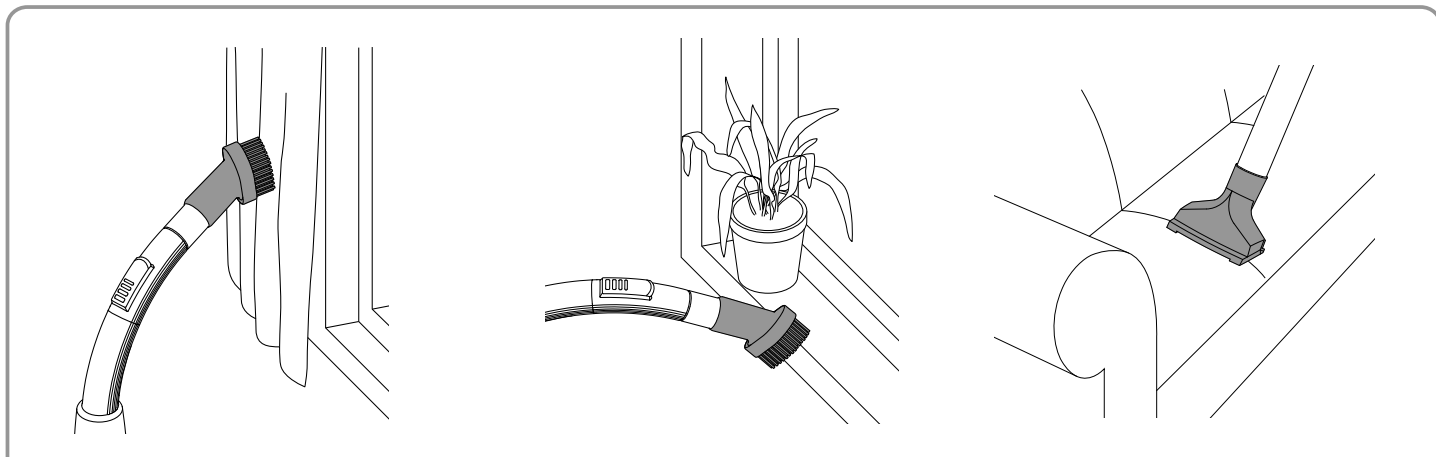

J 

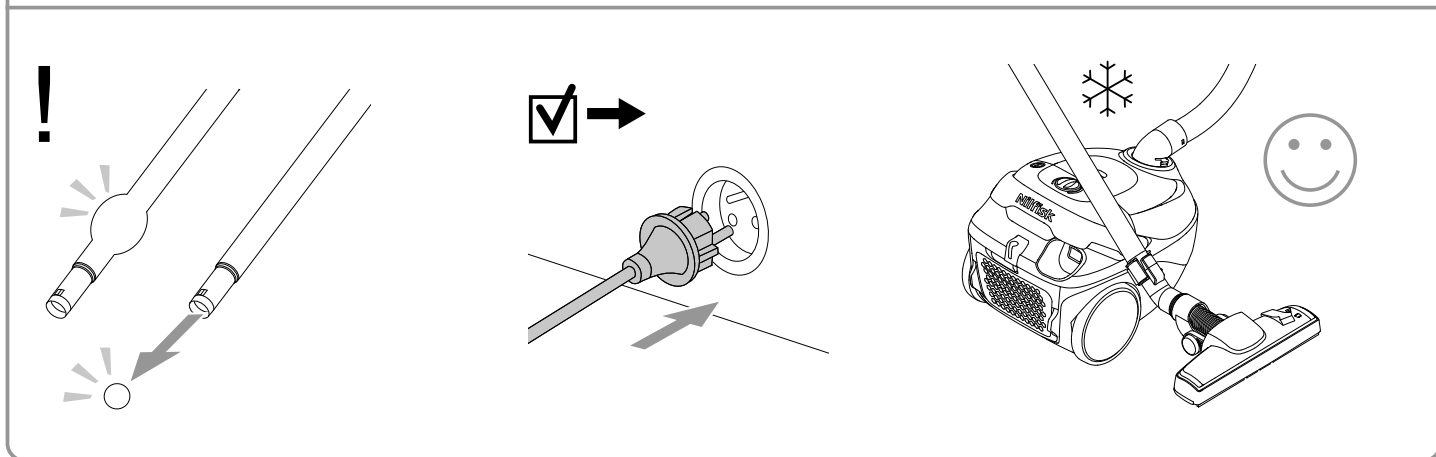
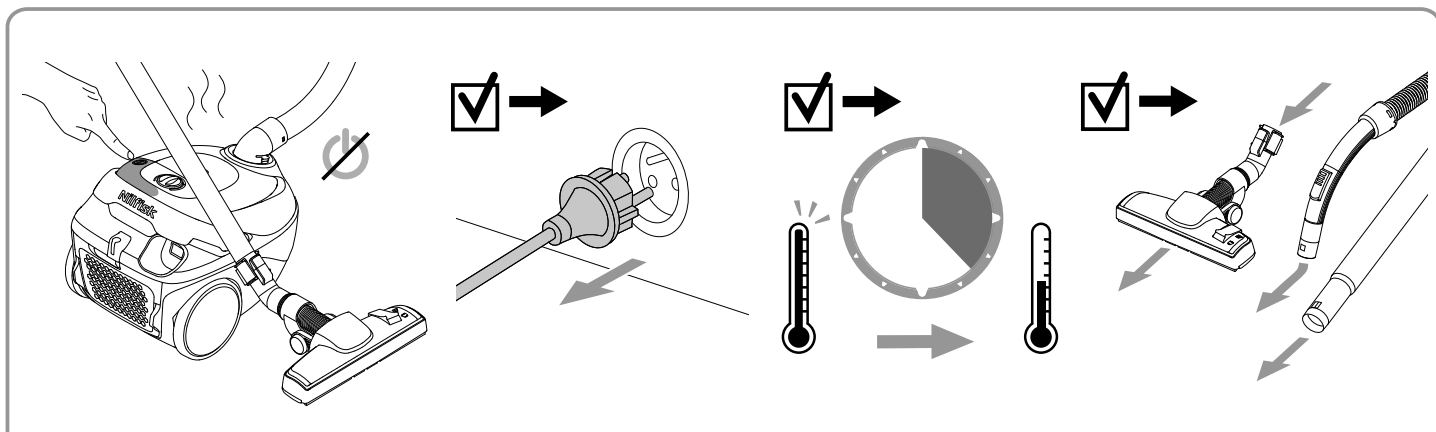

# K

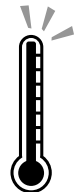
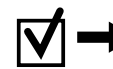
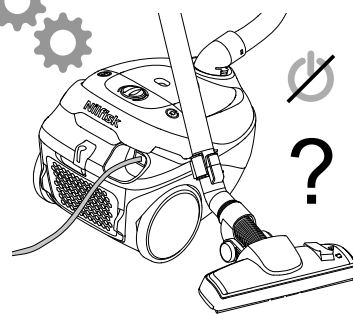
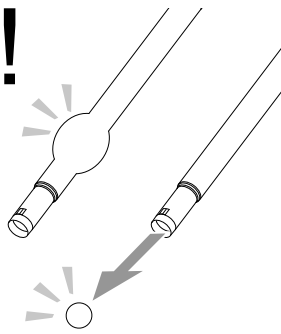
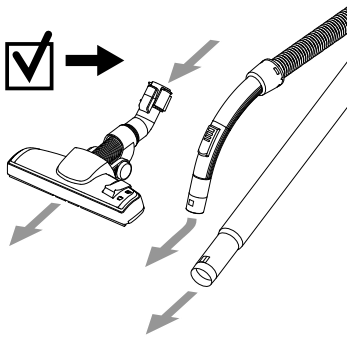
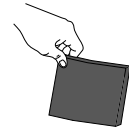
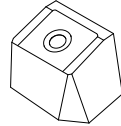
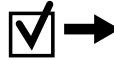
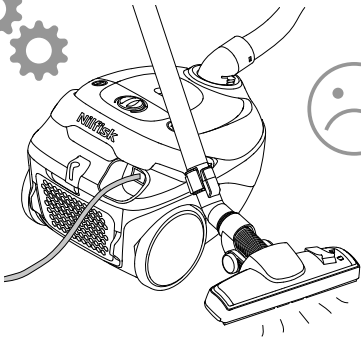

# L

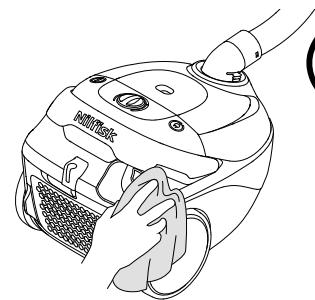
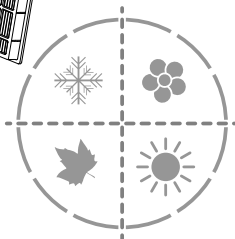
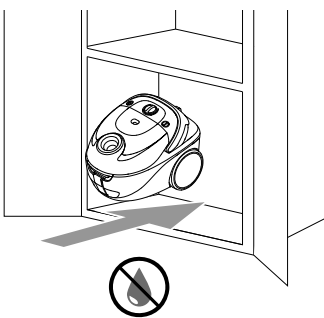



EU / UE / EL / EC / EE / ES / EÚ / AB

**Declaration of Conformity**

Prohlášení o shodě  
Konformitätserklärung  
Overensstemmelseserklæring  
Declaración de conformidad  
Vastavusdeklaratsioon  
Déclaration de conformité  
Vaatimustenmukaisuusvakuutus

Декларация за съответствие  
Δήλωση συμμόρφωσης  
Megfelelősségi nyilatkozat  
Izjava o skladnosti  
Dichiarazione di conformità  
Atitikties deklaracija  
Atbilstības deklarācija  
Samsvarserklæring  
Conformiteitsverklaring

Declaração de conformidade  
Declaracja zgodności  
Declaratie de conformitate  
Декларация о соответствии  
Försäkran om överensstämmelse  
Vyhlasenie o zhode  
Izjava o skladnosti  
Uygunluk beyanı

**Manufacturer /** Výrobce / Hersteller / Fabrikant / Fabricante / Κατασκευαστής /  
Gyártó / Proizvođač / Fabbicante / Gamintojas / Ražotājs / Produzent / Fabrikant /  
Fabricante / Producent / Producător / производитель / Tillverkaren / Výrobca /  
Proizvajalec / Üretici firma:

**Nilfisk A/S, Kornmarksvej 1  
DK-2605 Broendby, DENMARK**

**Product /** Produkt / Producto, Toode, Produit, Tuote / Продукт /  
Προϊόν / Termék / Proizvod / Prodotto / Produktas / Produkts /  
Artikel / Produtos / Prods / Izdelek / Ürün

**One Performance Basic\*, One Energy Basic\*, One  
Performance Prime\*, where \* means Country  
Code**

**Description /** Popis / Beschreibung / Beskrivelse / Descripción /  
Kirjeldus / La description / Kuvaus / Описание / Περιγραφή / Leirás /  
Opis / Descrizione / Aprašymas / Apraksts / Beschrijving / Descrição /  
Descriere / Beskrivning / Popis / Açıklama

**VAC - Consumer - Dry  
220-240V 50-60Hz, IPX0**

- |   |   |   |
|---|---|---|
| <b>EN</b> We, Nilfisk hereby declare under our sole responsibility, that the above-mentioned product(s) is/are in conformity with the following directives and standards. | <b>BG</b> Ние, Nilfisk С настоящото декларираме на своя лична отговорност, че посочените по-горе продуктът е в съответствие със следните директиви и стандарти. | <b>PT</b> Nós, a Nilfisk declaramos, sob nossa exclusiva responsabilidade, que o produto acima mencionado está em conformidade com as diretrizes e normas a seguir. |
| <b>CS</b> My, Nilfisk prohlašujeme na svou výlučnou odpovědnost, že výše uvedený výrobek je ve shodě s následujícími směrnici a normami.                                  | <b>EL</b> Εμείς, Nilfisk δηλώνουμε με αποκλειστική μας ευθύνη, ότι το προαναφερόμενο προϊόν συμμορφώνεται με τις ακόλουθες οδηγίες και πρότυπα.                 | <b>PL</b> My, Nilfisk Niniejszym oświadczamy z pełną odpowiedzialnością, że wyżej wymieniony produkt jest zgodny z następującymi dyrektywami i normami..            |
| <b>DE</b> Wir, Nilfisk erklären in alleiniger Verantwortung, dass das oben genannte Produkt den folgenden Richtlinien und Normen entspricht.                              | <b>HU</b> Mi, Nilfisk Kijelentjük, egyedüli felelősséggel, hogy a fent említett termék megfelel az alábbi irányelveknek és szabványoknak                        | <b>RO</b> Noi, Nilfisk Prin prezenta declarăm pe propria răspundere, că produsul mai sus menționat este în conformitate cu următoarele standarde și directive.      |
| <b>DA</b> Vi, Nilfisk erklærer hermed under eget ansvar at ovennævnte produkt(er) er i overensstemmelse med følgende direktiver og standarder.                            | <b>HR</b> Mi, Nilfisk Izjavljujemo pod punom odgovornošću, da gore navedeni proizvod u skladu sa sljedećim direktivama i standardima.                           | <b>RU</b> Мы, Nilfisk настоящим заявляем под нашу полную ответственность, что вышеперечисленные продукция соответствует следующими директивам и стандартам.         |
| <b>ES</b> Nosotros, Nilfisk declaramos bajo nuestra única responsabilidad que el producto antes mencionado está en conformidad con las siguientes directivas y normas     | <b>IT</b> Noi, Nilfisk dichiara sotto la propria responsabilità, che il prodotto di cui sopra è conforme alle seguenti direttive e norme.                       | <b>SV</b> Vi Nilfisk förklarar härmed under eget ansvar att ovan nämnda produkt överensstämmer med följande direktiv och normer.                                    |
| <b>ET</b> Meie, Nilfisk Käesolevaga kinnitame ja kanname ainusikulist vastutust, et eespool nimetatud toode on kooskõlas järgmiste direktiivide ja                        | <b>LT</b> Mes, "Nilfisk pareiškiu vienašališkos atsakomybės, kad pirmiau minėtas produkto atitinka šias direktyvas ir standartus                                | <b>SK</b> My, Nilfisk prehlasujeme na svoju výlučnú zodpovednosť, že vyššie uvedený výrobok je v zhode s nasledujúcimi smernicami a normami.                        |
| <b>FR</b> Nilfisk déclare sous notre seule responsabilité que le produit mentionné ci-dessus est conforme aux directives et normes suivantes.                             | <b>LV</b> Mēs, Nilfisk šo apliecinu ar pilnu atbildību, ka iepriekš minētais produkts atbilst šādām direktīvām un standartiem                                   | <b>SL</b> Mi, Nilfisk izjavljamo s polno odgovornostjo, da je zgoraj omenjeni izdelek v skladu z naslednjimi smernicami in standardi.                               |
| <b>FI</b> Me, Nilfisk täten vakuutamme omalla vastuulla, että edellä mainittu tuote on yhdenmukainen seuraavien direktiivien ja standardien mukaisesti                    | <b>NO</b> Vi, Nilfisk erklærer herved under eget ansvar, at det ovennevnte produktet er i samsvar med følgende direktiver og standarder                         | <b>TR</b> Nilfisk, burada yer alan tüm sorumluluklarımızı göze, yukarıda belirtilen ürünün aşağıdaki direktifler ve standartlara uygun olduğunu beyan ederiz.       |
| <b>NL</b> We verklaren Nilfisk hierbij op eigen verantwoordelijkheid, dat het bovengenoemde product voldoet aan de volgende richtlijnen en normen                         |   |   |

2014/35/EU	EN 60335-1:2012+A11:2014+A13:2017+A1:2019+A2:2019+A14:2019 EN 60335-2-2:2010+A11:2012+A1:2013
2014/30/EU	EN 55014-1:2017 EN 55014-2:2015 EN 61000-3-2:2014 EN 61000-3-3:2013
2011/65/EU	EN 50581:2012
2009/125/EC 666/2013/EU	EN 60312-1:2017 EN 60704-2-1:2015

Authorized signatory: Pierre Mikaelsson, Executive Vice President, Global Products & Services, Nilfisk NLT

May 11, 2020



## HEAD QUARTER

### DENMARK

Nilfisk A/S  
Kornmarksvej 1  
DK-2605 Broendby  
Tel.: (+45) 4323 8100  
Website: www.nilfisk.com

## SALES COMPANIES

### ARGENTINA

Nilfisk srl.  
Edificio Central Park  
Herrera 1855, 6th floor/604  
Ciudad de Buenos Aires  
Tel.: (+54) 11 6091 1571  
Website: www.consumer.nilfisk.com.ar

### AUSTRALIA

Nilfisk Pty Ltd  
Unit 1/13 Bessemer Street  
Blacktown NSW 2148  
Tel.: (+61) 2 98348100  
Website: www.consumer.nilfisk.com.au

### AUSTRIA

Nilfisk GmbH  
Metzgerstrasse 68  
5101 Bergheim bei Salzburg  
Tel.: (+43) 662 456 400 90  
Website: www.nilfisk.at

### BELGIUM

Nilfisk n.v.s.a.  
Riverside Business Park  
Boulevard Internationaledaan 55  
Bâtiment C3/C4 Gebouw  
Bruxelles 1070  
Tel.: (+32) 24 67 60 50  
Website: www.consumer.nilfisk.be

### Brazil

Nilfisk do Brasil  
Av. Eng. Luis Carlos Berrini, 550  
40 Andar, Sala 03  
SP - 04571-000 Sao Paulo  
Tel.: (+11) 3959-0300 / 3945-4744  
Website: www.nilfisk.com.br

### CANADA

Nilfisk Canada Company  
240 Superior Boulevard  
Mississauga, Ontario L5T 2L2  
Tel.: (+1) 800-668-8400  
Website: www.nilfisk.ca

### CHILE

Nilfisk S.A. (Comercial KCS Ltda)  
Salar de Llamara 822  
8320000 Santiago  
Tel.: (+56) 2684 5000  
Website: www.nilfisk.cl

### CHINA

Nilfisk  
4189 Yindu Road  
Xinzhuan Industrial Park  
201108 Shanghai  
Tel.: (+86) 21 3323 2000  
Website: www.nilfisk.cn

### CZECH REPUBLIC

Nilfisk s.r.o.  
VGP Park Horní Počernice  
Do Čertous 1/2658  
193 00 Praha 9  
Tel.: (+420) 244 090 912  
Website: www.consumer.nilfisk.cz

### DENMARK

Nilfisk A/S  
Kornmarksvej 1  
2605 Broendby  
Tel.: (+45) 4323 4050  
Website: www.consumer.nilfisk.dk

### FINLAND

Nilfisk Oy Ab  
Koskelontie 23 E  
02920 Espoo  
Tel.: (+358) 207 890 600  
Website: www.consumer.nilfisk.fi

### FRANCE

Nilfisk SAS  
26 Avenue de la Baltique  
Villebon sur Yvette  
91978 Courtaubouef Cedex  
Tel.: (+33) 169 59 87 24  
Website: www.consumer.nilfisk.fr

### GERMANY

Nilfisk GmbH  
Guido-Oberdorfer-Strasse 2-10  
89287 Bellenberg  
Tel.: (+49) (0)7306/72-444  
Website: www.consumer.nilfisk.de

### GREECE

Nilfisk A.E.  
Αναπαύσεως 29  
Κορωπί Τ.Κ. 194 00

Tel.: (30) 210 9119 600  
Website: www.consumer.nilfisk.gr

### HOLLAND

Nilfisk B.V.  
Versterkerstraat 5  
1322 AN Almere  
Tel.: (+31) 036 5460760  
Website: www.consumer.nilfisk.nl

### HONG KONG

Nilfisk Ltd.  
2001 HK Worsted Mills  
Industrial Building  
31-39, Wo Tong Tsui St.  
Kwai Chung, N.T.  
Tel.: (+852) 2427 5951  
Website: www.nilfisk.com

### HUNGARY

Nilfisk Kft.  
II. Rákóczi Ferenc út 10  
2310 Szigetszentmiklós-Lakihegy  
Tel.: (+36) 24 475 550  
Website: www.nilfisk.hu

### INDIA

Nilfisk India Limited  
Pramukh Plaza, 'B' Wing, 4th floor, Unit No. 403  
Cardinal Gracious Road, Chakala  
Andheri (East) Mumbai 400 099  
Tel.: (+91) 22 6118 8188  
Website: www.nilfisk.in

### IRELAND

Nilfisk  
1 Stokes Place  
St. Stephen's Green  
Dublin 2  
Tel.: (+35) 3 12 94 38 38  
Website: www.nilfisk.ie

### ITALY

Nilfisk SpA  
Strada Comunale della Braglia, 18  
26862 Guardamiglio (LO)  
Tel.: (+39) (0) 377 414021  
Website: www.nilfisk.it

### JAPAN

Nilfisk Inc.  
1-6-6 Kita-shinyokohama, Kouhoku-ku  
Yokohama, 223-0059  
Tel.: (+81) 45548 2571  
Website: www.nilfisk.com

### MALAYSIA

Nilfisk Sdn Bhd  
Sd 33, Jalan KIP 10  
Taman Perindustrian KIP  
Sri Damansara  
52200 Kuala Lumpur  
Tel.: +603 6275 3120  
Website: www.nilfisk.com

### MEXICO

Nilfisk de Mexico, S. de R.L. de C.V.  
Pirneos #515 Int.  
60-70 Microparque  
Industrial WSantiago  
76120 Queretaro  
Tel.: (+52) (442) 427 77 00  
Website: www.nilfisk.com

### NEW ZEALAND

Nilfisk Limited  
Suite F, Building E  
42 Tawa Drive  
0632 Albany Auckland  
Tel.: (+64) 9 414 1996  
Website: www.nilfisk.com

### NORWAY

Nilfisk AS  
Bjørnerudveien 24  
1266 Oslo  
Tel.: (+47) 22 75 17 80  
Website: www.consumer.nilfisk.no

### PERU

Nilfisk S.A.C.  
Calle Boulevard 162, Of. 703, Lima 33- Peru  
Lima  
Tel.: (511) 435-6840  
Website: www.nilfisk.com

### POLAND

Nilfisk Sp. Z.O.O.  
Millenium Logistic Park  
ul. 3 Maja 8, Bud. B4  
05-800 Pruszków  
Tel.: (+48) 22 738 3750  
Website: www.consumer.nilfisk.pl

### PORTUGAL

Nilfisk Lda.  
Sintra Business Park  
Zona Industrial Da Abrunheira  
Edifício 1, 1º A  
P2710-089 Sintra  
Tel.: (+351) 21 911 2670  
Website: www.nilfisk.pt

### RUSSIA

Nilfisk LLC

Vyatskaya str. 27, bld. 7/1st  
127015 Moscow  
Tel.: (+7) 495 783 9602  
Website: www.consumer.nilfisk.ru

### SINGAPORE

Den-Sin  
22 Tuas Avenue 2  
639453 Singapore  
Tel.: (+65) 6268 1006  
Website: www.densin.com

### SLOVAKIA

Nilfisk s.r.o.  
Bancíkovej 1/A  
SK-821 03 Bratislava  
Tel.: (+421) 910 222 928  
Website: www.consumer.nilfisk.sk

### SOUTH AFRICA

Nilfisk (Pty) Ltd  
Kimbulk Office Park, 9 Zeiss Road  
Laser Park, Honeydew  
Johannesburg  
Tel.: (+27) 118014600  
Website: www.nilfisk.co.za

### SOUTH KOREA

Nilfisk Korea  
3F Duksoo B/D. 317-15  
Sungsoo-Dong 2Ga  
Sungdong-Gu, Seoul  
Tel.: (+82) 2497 8636  
Website: www.nilfisk.co.kr

### SPAIN

Nilfisk S.A.U  
Paseo del Rengle, 5 Planta. 9-10  
08302 Mataró  
Tel.: (+34) 93 741 2400  
Website: www.consumer.nilfisk.es

### SWEDEN

Nilfisk AB  
Taljegårdsgatan 4  
431 53 Mölndal  
Tel.: (+46) 31 706 73 00  
Website: www.consumer.nilfisk.se

### SWITZERLAND

Nilfisk AG  
Ringstrasse 19  
Kircheberg/Industri Stelz  
9500 Wil  
Tel.: (+41) 71 92 38 444  
Website: www.consumer.nilfisk.ch

### TAIWAN

Nilfisk Ltd  
Taiwan Branch (H.K)  
No. 5, Wan Fang Road  
Taipei  
Tel.: (+88) 6227 00 22 68  
Website: www.nilfisk.tw

### THAILAND

Nilfisk Co. Ltd.  
89 Soi Chokechai-Ruammitr  
Viphavadee-Rangsit Road  
Ladyao, Jatuchak, Bangkok 10900  
Tel.: (+66) 2275 5630  
Website: www.nilfisk.co.th

### TURKEY

Nilfisk A.S.  
Serifali Mh. Bayraktar Bulv. Sehit Sk. No:7  
Ümraniye, 34775 Istanbul  
Tel.: +90 216 466 94 94  
Website: www.consumer.nilfisk.com.tr

### UNITED ARAB EMIRATES

Nilfisk Middle East Branch  
SAIF-Zone  
P.O. Box 122298  
Sharjah  
Tel.: (+971) (0) 655-78813  
Website: www.nilfisk.com

### UNITED KINGDOM

Nilfisk Ltd.  
Nilfisk House, Bowerbank Way  
Gilwilly Industrial Estate, Penrith  
Cumbria CA11 9BQ  
Tel.: (+44) (0) 1768 868995  
Website: www.consumer.nilfisk.co.uk

### UNITED STATES

Nilfisk Inc.  
14600 21st Avenue North  
Plymouth, MN-55447  
Tel.: (+1) 800-989-2235  
Website: www.nilfisk.com

### VIETNAM

Nilfisk Vietnam  
No. 51 Doc Ngu Str.  
P. Vinh Phúc, Q.Ba Dinh  
Hanoi  
Tel.: (+84) 761 5642  
Website: www.nilfisk.com

