

One

사용 방법



안전 주의사항

 청소기를 처음 사용하시는 분들은 이 매뉴얼의 안전 주의사항에 관한 내용을 꼼꼼히 읽어보시기 바랍니다. 나중에 필요할 수도 있으므로 주의사항을 잘 보관해 두십시오.

주의!

- ⚠️ 청소기에 적합한 먼지 봉투와 필터 없이는 작동시키지 마십시오.
- ⚠️ 이 청소기는 유해 물질 또는 가스를 빨아들이기 위해 만들어진 것이 아닙니다. 이러한 용도로 사용될 경우, 인체에 심각한 위험을 초래할 수 있습니다.
- ⚠️ 물이나 액체를 빨아들이는 용도로 이 청소기를 사용하지 마십시오.
- ⚠️ 바늘이나 깨진 유리조각같이 날카로운 물체를 빨아들이는 용도로 이 청소기를 사용하지 마십시오.
- ⚠️ 담배꽂초, 성냥 또는 뜨거운 재 같이 불이 붙어있거나 연기나는 물체를 빨아들이는 용도로 이 청소기를 사용하지 마십시오.
- ⚠️ 청소기는 0 °C 에서 60 °C 사이의 건조한 실내에서 사용하고 보관하십시오.
- ⚠️ 이 청소기를 실외용으로 사용하지 마십시오.
- ⚠️ 자동 케이블 되감기 기능을 실행할 때, 케이블 끝의 플러그 부분이 되감기 마지막 단계에서 요동을 치며 크게 흔들릴 수 있으므로 주의를 기울여야 합니다. 케이블을 되감을 때는 플러그를 손으로 잡고 실행하는 것이 좋습니다.
- ⚠️ 청소기를 젖은 손으로 작동시키지 마십시오.
- ⚠️ 전원 플러그를 빼기 전에 청소기 전원을 먼저 끄십시오.
- ⚠️ 전원 플러그를 뺄 때는 플러그를 잡고 빼야 하며 전선을 잡아당겨 빼서는 안 됩니다. 청소기 전선을 잡아 당겨 청소기를 움직이거나 이동하지 마십시오.
- ⚠️ 전선에 손상을 입은 것이 보이면 이 청소기를 사용하면 안 됩니다. 주기적으로 전선이 손상을 입었는지 점검하고 특히 전선이 짓눌렸거나 문틈에 끼여 손상된 부분은 없는지 확인하십시오.
- ⚠️ 청소기에서 결함이 발견됐으면 사용하지 마십시오. 청소기를 떨어트렸거나 파손되었거나 실외에 방치하였거나 물에 노출된 경우에는 승인된 서비스 센터에서 점검을 받으시기 바랍니다.
- ⚠️ 기계적, 전기적인 안전 장치에 대해 변형을 하거나 개조를 하지 마십시오.
- ⚠️ 모든 수리는 승인된 서비스 센터에서 받으시기 바랍니다.
- ⚠️ 지역 대리점에서 구입한 정품 먼지 봉투, 정품 필터, 그리고 정품 액세서리만 사용하십시오. 승인되지 않은 먼지 봉투와 필터를 사용하는 경우 제

품 보증을 받을 수 없습니다.

- ⚠️ 먼지 봉투나 필터를 교체하기 전에 반드시 청소기 전원을 끄고 플러그를 빼야 합니다. 전원 플러그를 뺄 때는 플러그를 잡고 빼야 하며 전선을 잡아당겨 빼서는 안 됩니다.
- ⚠️ 전선 코드가 손상된 경우 제조사, 제조사의 서비스 에이전트 또는 승인된 기술자가 교체하도록 하여 위험을 피해야 합니다.
- ⚠️ 터보 노즐이 사용중일 때는 회전하는 부분을 손으로 만지면 안 됩니다.
- ⚠️ 이 청소기는 8세 이상의 어린이부터 사용할 수 있으며 신체적, 감각적, 정신적 능력이 떨어지는 사람 또는 경험이나 지식이 부족한 사람이라도 안전한 기계사용과 관련해 감독이나 지시를 받고 관련 위험을 이해하고 있다면 이 청소기를 사용할 수 있습니다.
- ⚠️ 감독없이 어린이들이 청소기를 청소하거나 정비 작업을 할 수 없습니다.
- ⚠️ 어린이들이 이 청소기를 가지고 장난을 치지 못하도록 감독해야 합니다.
- ⚠️ 일회용 건전지를 충전하지 마십시오.
- ⚠️ 충전하기 전에 청소기에서 충전용 건전지를 빼십시오.
- ⚠️ 유형이 다른 건전지, 새 건전지와 헌 건전지를 섞어서 사용하지 마십시오.
- ⚠️ 건전지를 삽입할 때 전극이 올바르게 배치됐는지 확인하십시오.
- ⚠️ 사용이 끝난 건전지를 청소기에서 빼내고 안전하게 폐기하십시오.
- ⚠️ 청소기를 장기간 사용하지 않고 보관해 두어야 하는 경우, 건전지를 빼 놓으십시오.
- ⚠️ 공급 단자에 합선이 생기지 않도록 조심하십시오.

서비스 및 일반 유지관리

청소기는 실내의 건조한 곳에 보관하십시오.

- 예비 필터(pre-filter)는 먼지 봉투를 4번 째 교체할 때 마다 교체하십시오. 먼지 봉투 팩키지에는 4개의 먼지 봉투와 1개의 예비 필터가 들어 있습니다.
- 청소기 표면은 마른 천이나 세제를 묻힌 축축한 천으로 닦아 줍니다.
- 정품 액세서리는 지역 대리점에서 구입할 수 있습니다.
- 서비스는 지역 대리점을 통해 문의하시기 바랍니다.

책임 한계

Nilfisk는 올바르지 않은 사용이나 청소기의 개조 사용에 의해 발생한 모든 손상에 대해 책임을 지지 않습니다. 보다 많은 상세한 정보는 웹사이트 www.nilfisk.com 에서 확인해 볼 수 있습니다.

WEEE



이 심볼은 이 제품이 일반 가정 쓰레기와 함께 취급되면 안 되고, 별도로 분리수거돼야 한다는 표시입니다. 재활용을 위해 폐기해야 할 청소기를 해당 수거 장소에 올바른 방법으로 버려 주십시오.

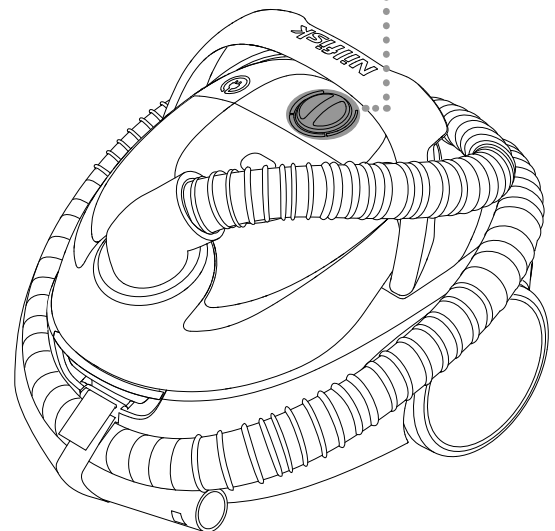
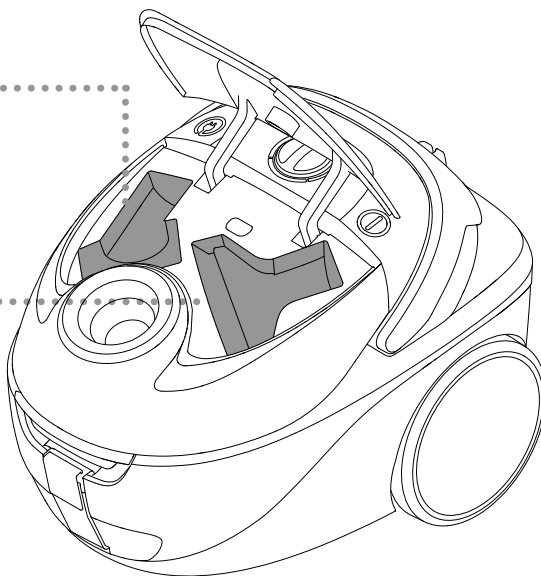
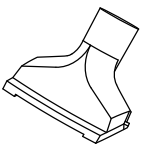
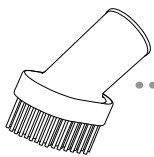
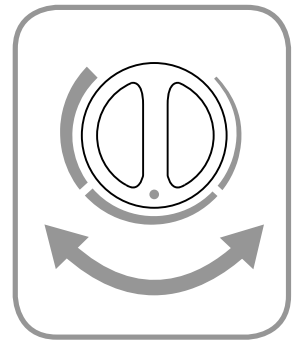
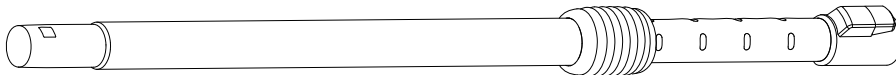
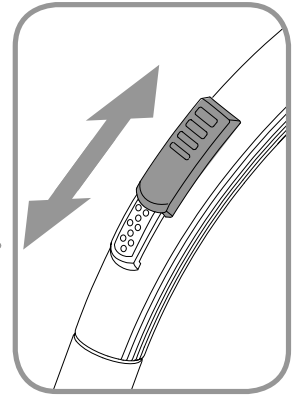
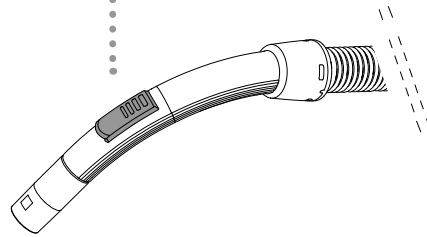
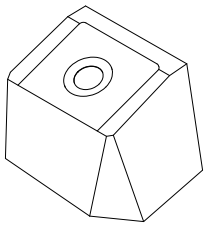
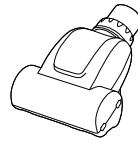
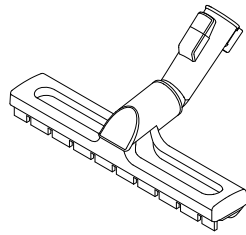
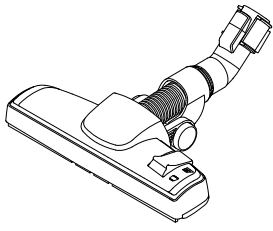

청소기의 모델에 따라 서로 다른 타입의 노즐이 공급될 수 있습니다.

A

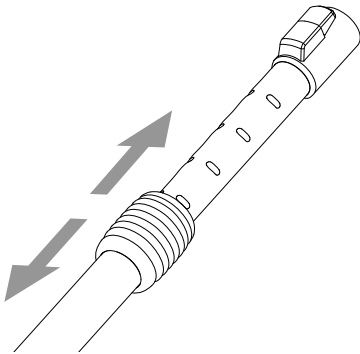
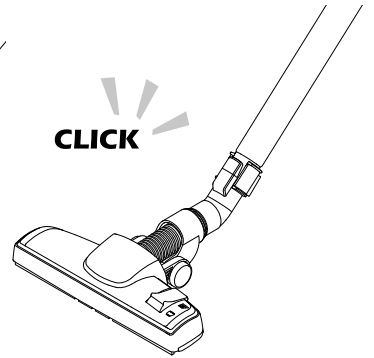
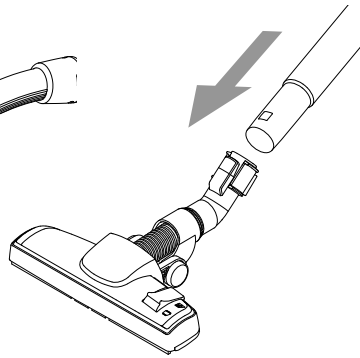
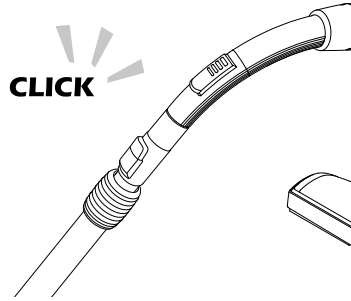
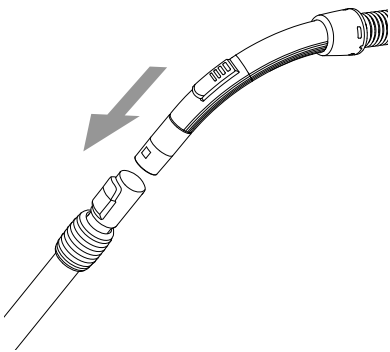
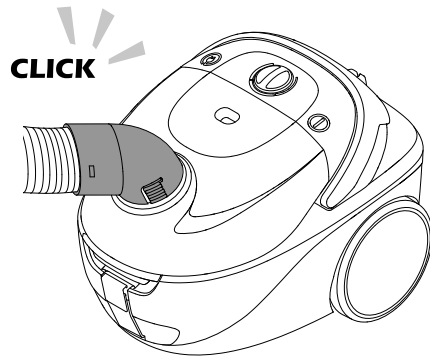
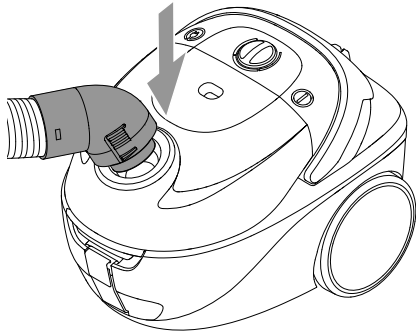

B

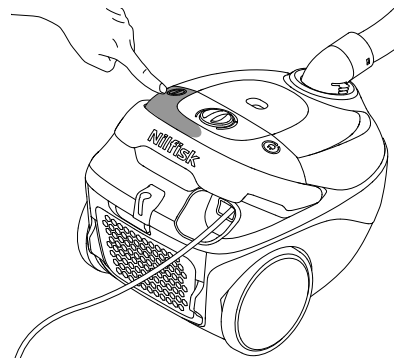
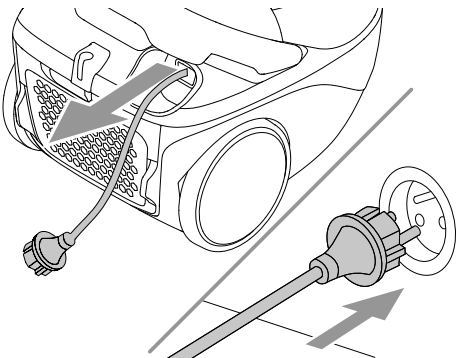

C 

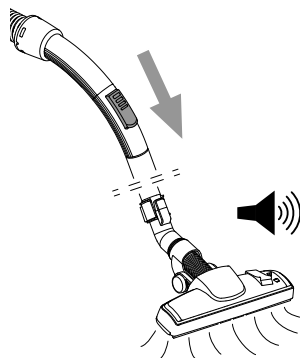
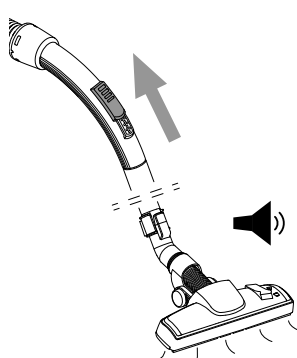
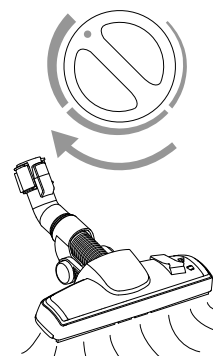
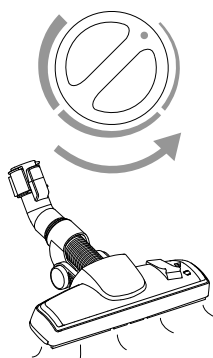
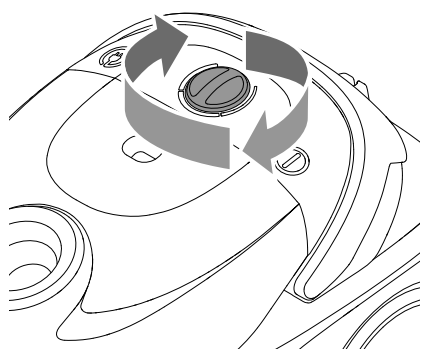

D 

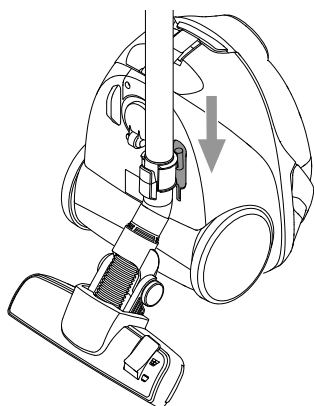
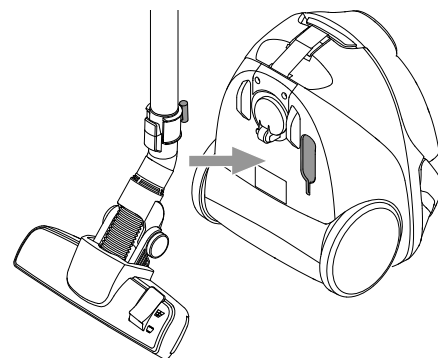
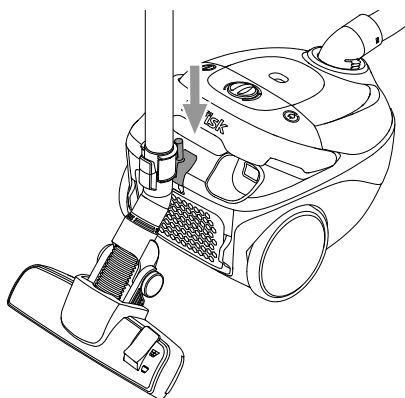
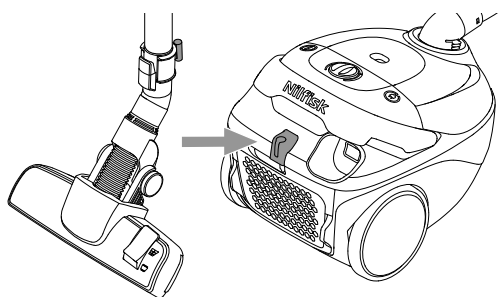

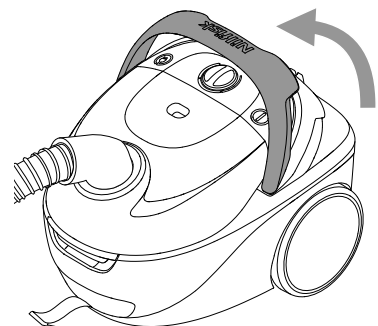
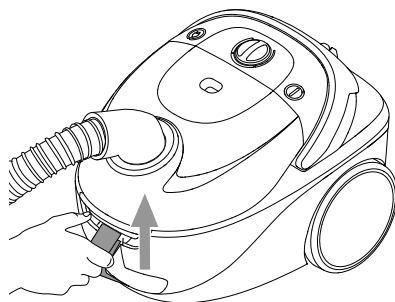
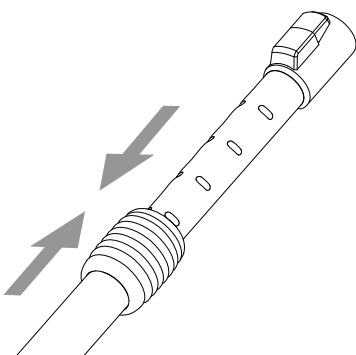
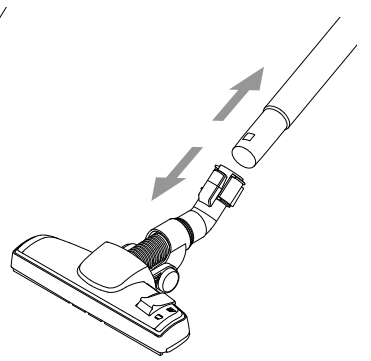
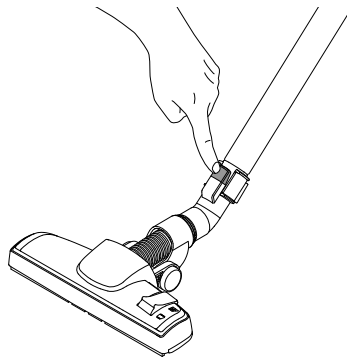
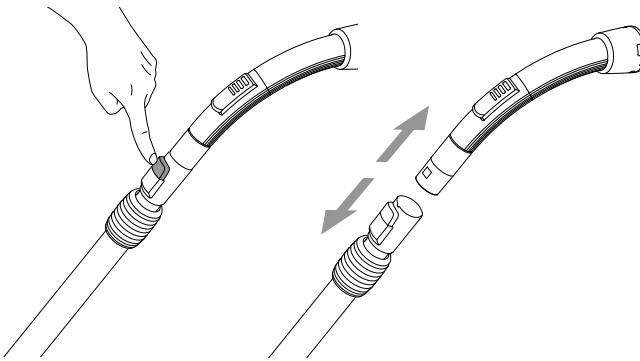
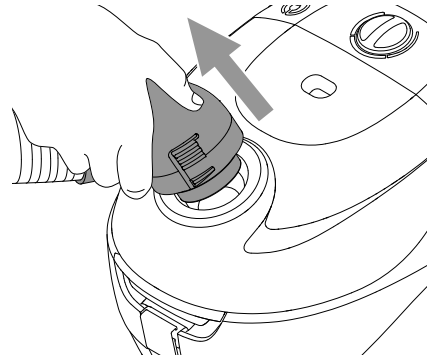
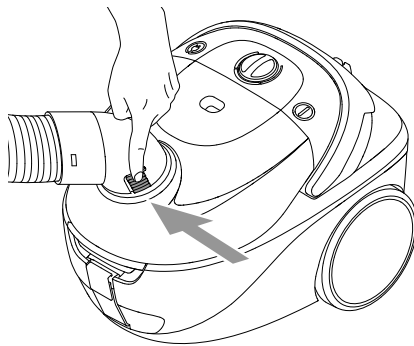
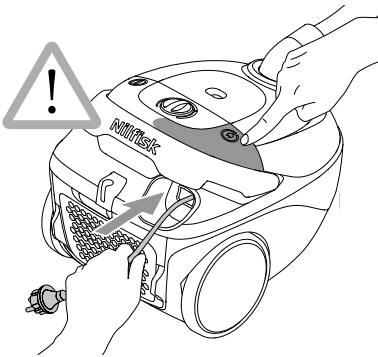
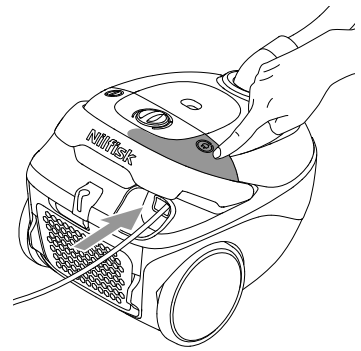
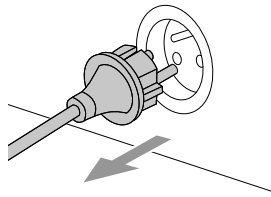
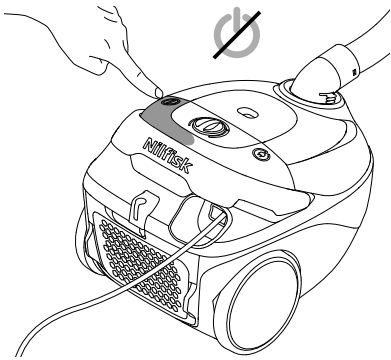

G

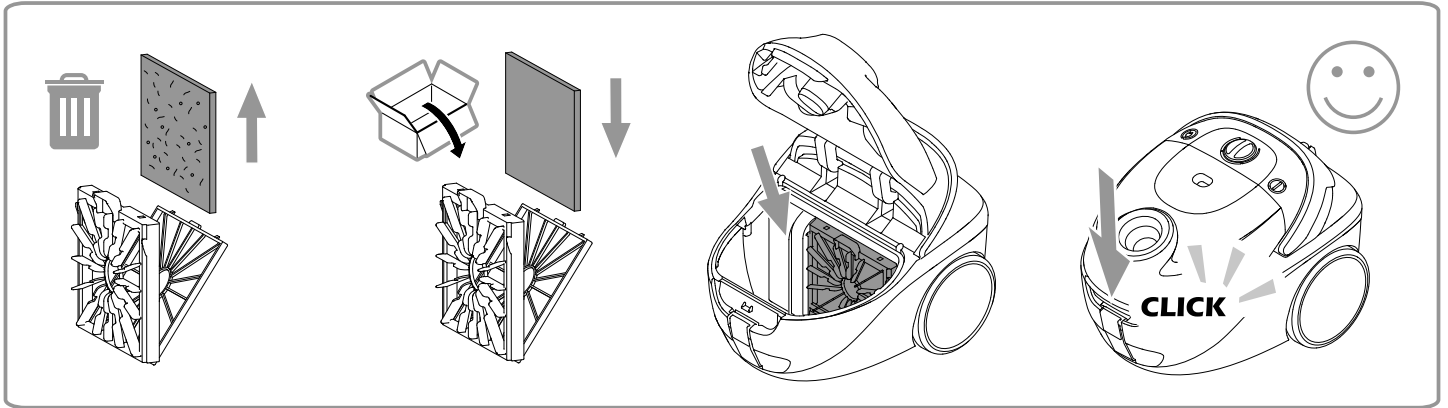

H

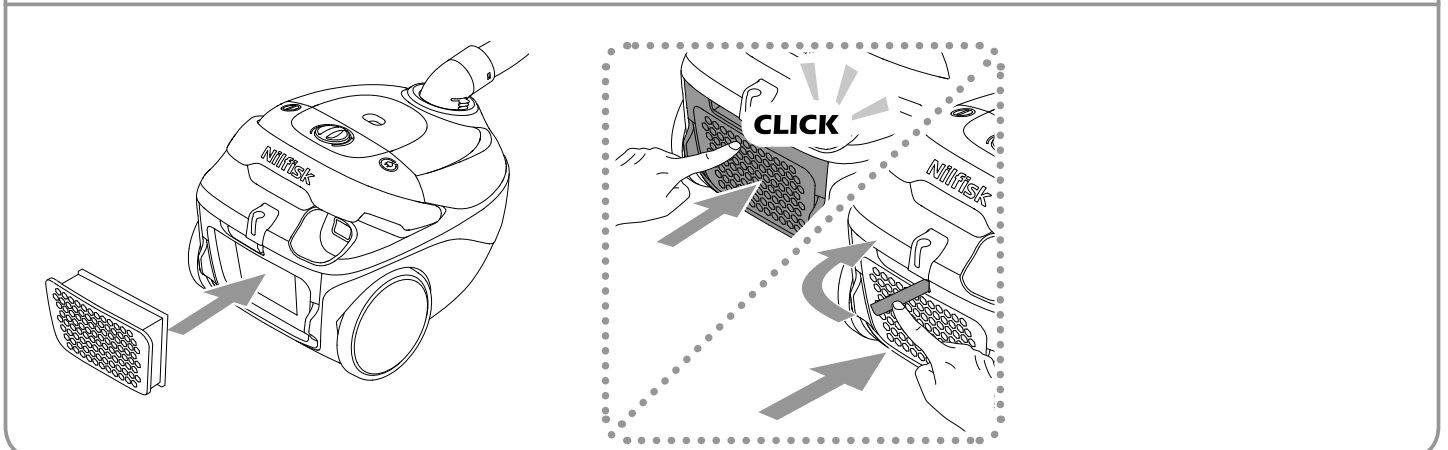
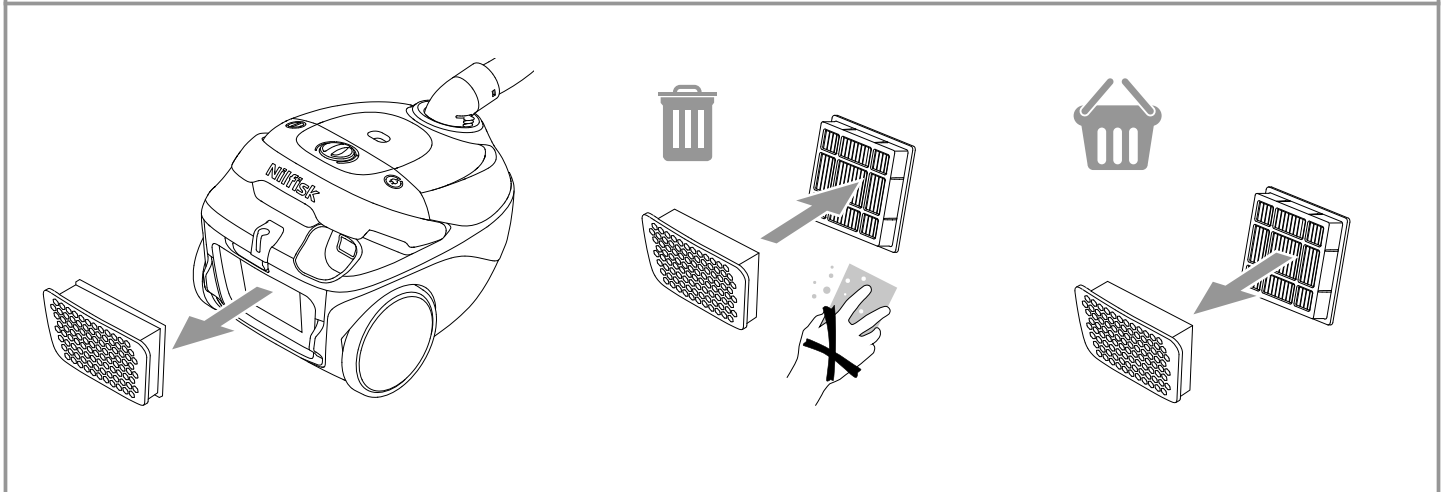
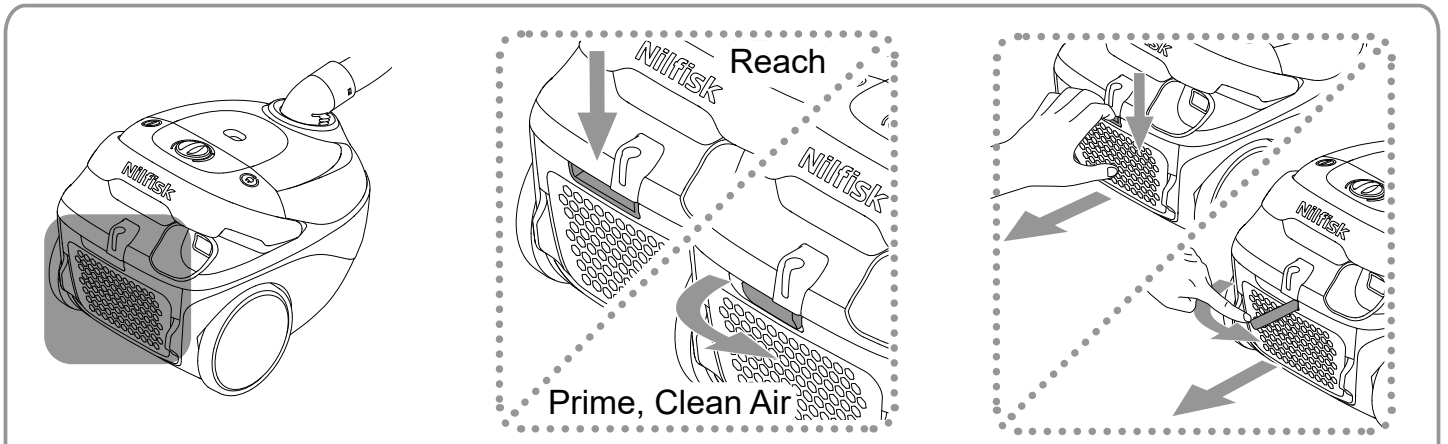

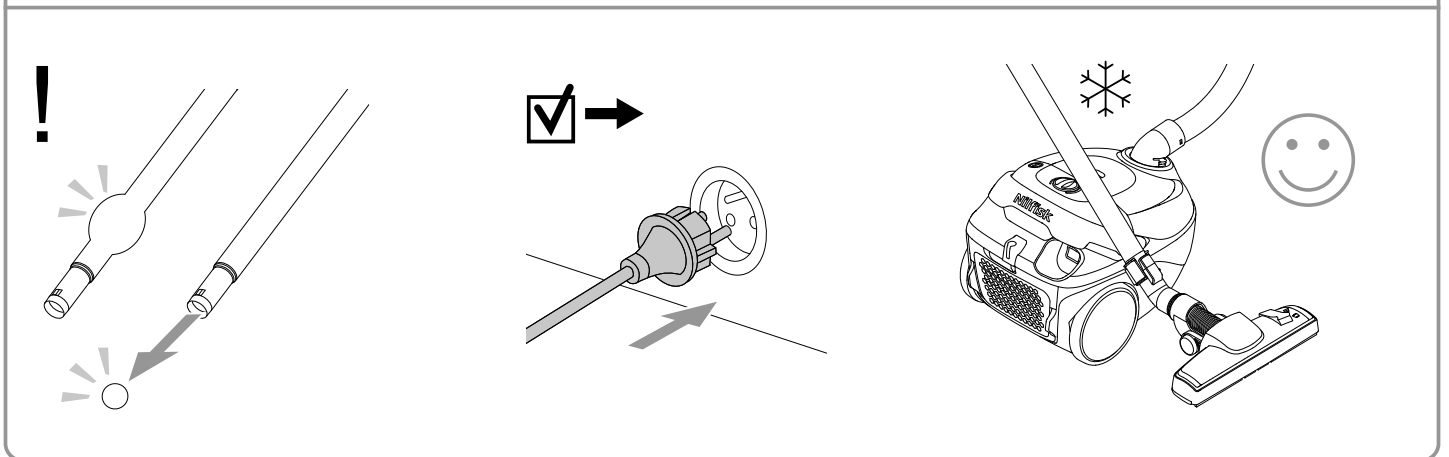
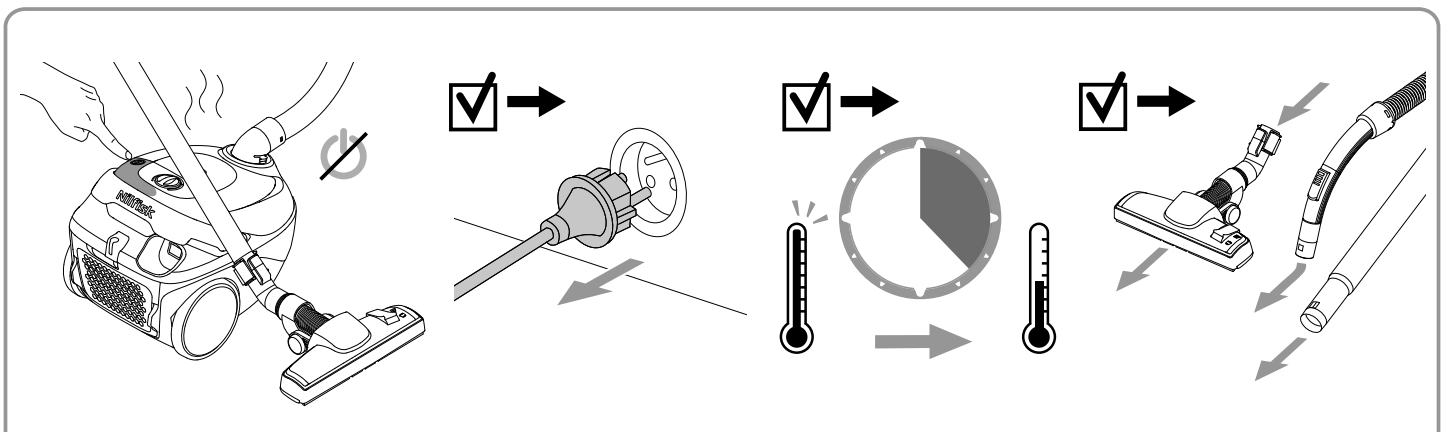
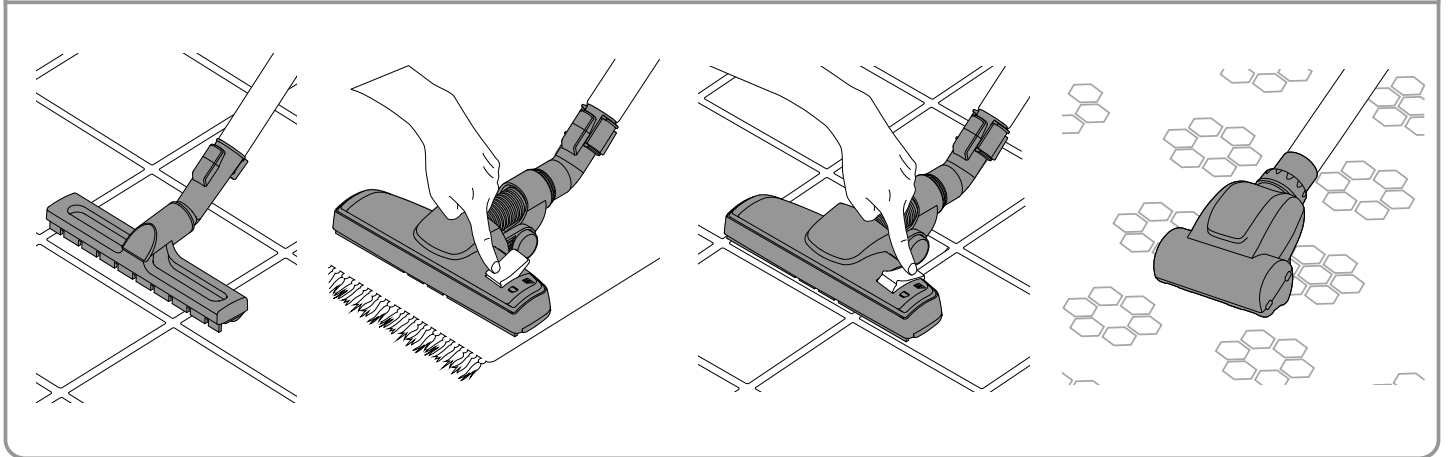
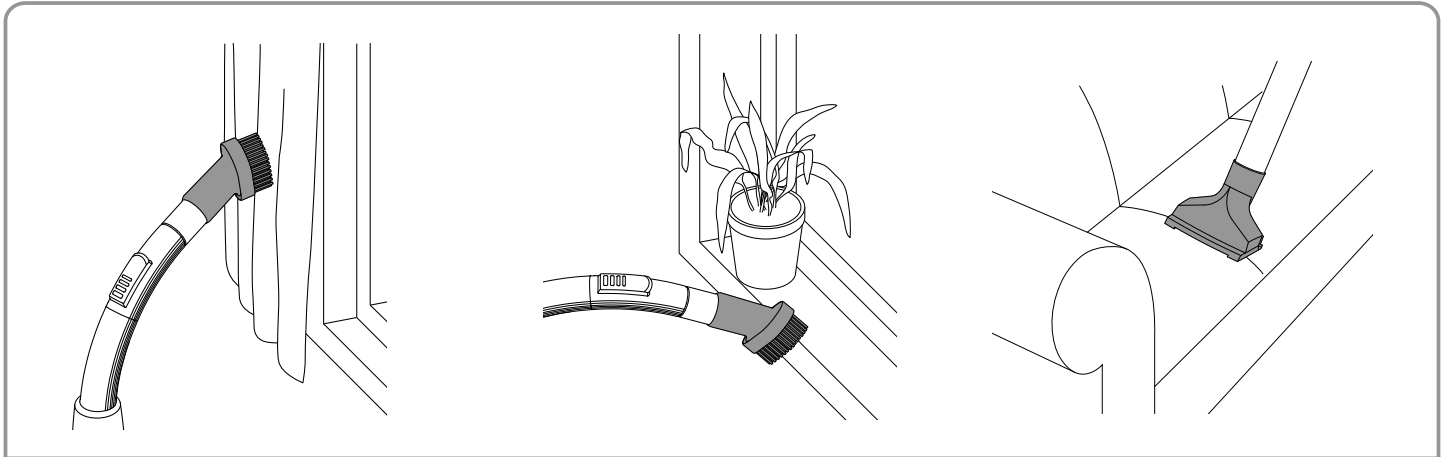

K

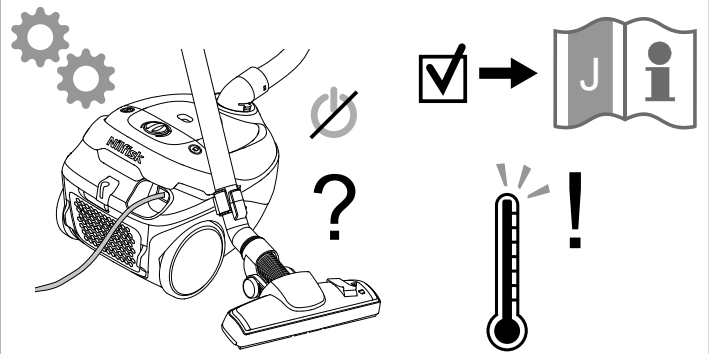
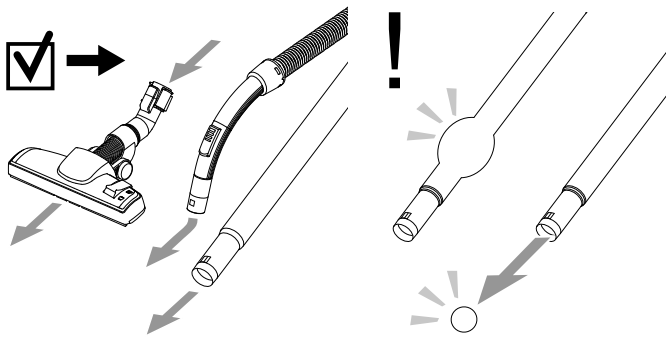
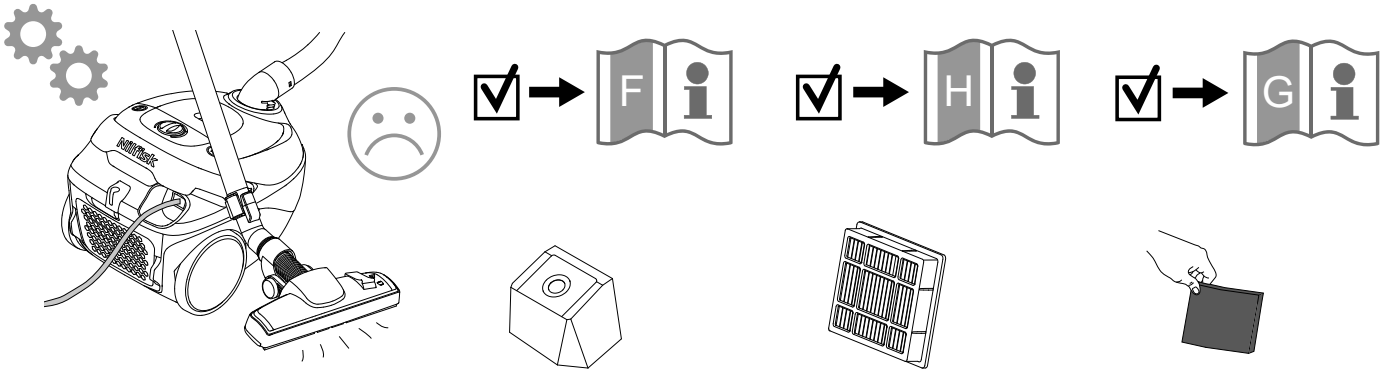

L

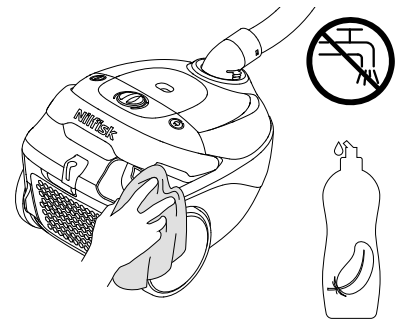
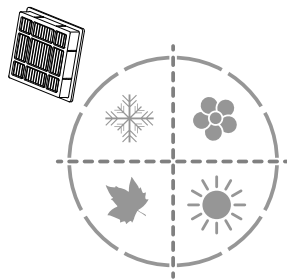
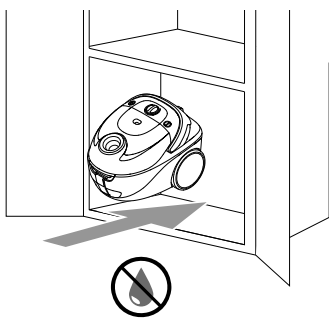



EU / UE / EL / EC / EE / ES / EÚ / AB

Declaration of Conformity

Prohlášení o shodě
Konformitätserklärung
Overensstemmelseserklæring
Declaración de conformidad
Vastavusdeklaratsioon
Déclaration de conformité
Vaatumustenmukaisuusvakuutus

Декларация за съответствие
Δήλωση συμμόρφωσης
Megfelelősségi nyilatkozat
Izjava o skladnosti
Dichiarazione di conformità
Atitikties deklaracija
Atbilstības deklarācija
Samsvarserklæring
Conformiteitsverklaring

Declaração de conformidade
Declaracja zgodności
Declaratie de conformitate
Декларация о соответствии
Försäkran om överensstämmelse
Vyhlasenie o zhode
Izjava o skladnosti
Uygunluk beyanı

Manufacturer / Výrobce / Hersteller / Fabrikant / Fabricante / Κατασκευαστής /
Gyártó / Proizvođač / Fabbricante / Gamintojas / Ražotājs / Produzent / Fabrikant /
Fabricante / Producent / Producător / производитель / Tillverkaren / Výrobca /
Proizvajalec / Üretici firma:

**Nilfisk A/S, Kornmarksvej 1
DK-2605 Broendby, DENMARK**

Product / Produkt / Producto, Toode, Produit, Tuote / Продукт /
Προϊόν / Termék / Proizvod / Prodotto / Produktas / Produkts /
Artikel / Produtos / Prods / Izdelek / Ürün

**One Performance Basic*, One Energy Basic*, One
Performance Prime*, where * means Country
Code**

Description / Popis / Beschreibung / Beskrivelse / Descripción /
Kirjeldus / La description / Kuvaus / Описание / Περιγραφή / Leirás /
Opis / Descrizione / Aprašymas / Apraksts / Beschrijving / Descrição /
Descriere / Beskrivning / Popis / Açıklama

**VAC - Consumer - Dry
220-240V 50-60Hz, IPX0**

- | | | |
|---|---|---|
| EN We, Nilfisk hereby declare under our sole responsibility, that the above-mentioned product(s) is/are in conformity with the following directives and standards. | BG Ние, Nilfisk с настоящото декларираме на своя лична отговорност, че посочените по-горе продуктът е в съответствие със следните директиви и стандарти. | PT Nós, a Nilfisk declaramos, sob nossa exclusiva responsabilidade, que o produto acima mencionado está em conformidade com as diretrizes e normas a seguir. |
| CS My, Nilfisk prohlašujeme na svou výlučnou odpovědnost, že výše uvedený výrobek je ve shodě s následujícími směrnici a normami. | EL Εμείς, Nilfisk δηλώνουμε με αποκλειστική μας ευθύνη, ότι το προαναφερόμενο προϊόν συμμορφώνεται με τις ακόλουθες οδηγίες και πρότυπα. | PL My, Nilfisk Niniejszym oświadczamy z pełną odpowiedzialnością, że wyżej wymieniony produkt jest zgodny z następującymi dyrektywami i normami.. |
| DE Wir, Nilfisk erklären in alleiniger Verantwortung, dass das oben genannte Produkt den folgenden Richtlinien und Normen entspricht. | HU Mi, Nilfisk kijelentjük, egyedüli felelősséggel, hogy a fent említett termék megfelel az alábbi irányelveknek és szabványoknak | RO Noi, Nilfisk Prin prezenta declarăm pe propria răspundere, că produsul mai sus menționat este în conformitate cu următoarele standarde și directive. |
| DA Vi, Nilfisk erklærer hermed under eget ansvar at ovennævnte produkt(er) er i overensstemmelse med følgende direktiver og standarder. | HR Mi, Nilfisk izjavljujemo pod punom odgovornošću, da gore navedeni proizvod u skladu sa sljedećim direktivama i standardima. | RU Мы, Nilfisk настоящим заявляем под нашу полную ответственность, что вышеперечисленные продукция соответствует следующими директивам и стандартам. |
| ES Nosotros, Nilfisk declaramos bajo nuestra única responsabilidad que el producto antes mencionado está en conformidad con las siguientes directivas y normas | IT Noi, Nilfisk dichiara sotto la propria responsabilità, che il prodotto di cui sopra è conforme alle seguenti direttive e norme. | SV Vi Nilfisk förklarar härmed under eget ansvar att ovan nämnda produkt överensstämmer med följande direktiv och normer. |
| ET Meie, Nilfisk Käesolevaga kinnitame ja kanname ainusikulist vastutust, et eespool nimetatud toode on kooskõlas järgmiste direktiivide ja | LT Mes, "Nilfisk pareiškiu vienašališkos atsakomybės, kad pirmiau minėtas produkts atitinka šias direktyvas ir standartus | SK My, Nilfisk prehlasujeme na svoju výlučnú zodpovednosť, že vyššie uvedený výrobok je v zhode s nasledujúcimi smernicami a normami. |
| FR Nilfisk déclare sous notre seule responsabilité que le produit mentionné ci-dessus est conforme aux directives et normes suivantes. | LV Mēs, Nilfisk šo apliecinu ar pilnu atbildību, ka iepriekš minētais produkts atbilst šādām direktīvām un standartiem | SL Mi, Nilfisk izjavljamo s polno odgovornostjo, da je zgoraj omenjeni izdelek v skladu z naslednjimi smernicami in standardi. |
| FI Me, Nilfisk täten vakuutamme omalla vastuulla, että edellä mainittu tuote on yhdenmukainen seuraavien direktiivien ja standardien mukaisesti | NO Vi, Nilfisk erklærer herved under eget ansvar, at det ovennevnte produktet er i samsvar med følgende direktiver og standarder | TR Nilfisk, burada yer alan tüm sorumluluklarımızı göze, yukarıda belirtilen ürünün aşağıdaki direktifler ve standartlara uygun olduğunu beyan ederiz. |
| NL We verklaren Nilfisk hierbij op eigen verantwoordelijkheid, dat het bovengenoemde product voldoet aan de volgende richtlijnen en normen | | |

2014/35/EU	EN 60335-1:2012+A11:2014+A13:2017+A1:2019+A2:2019+A14:2019 EN 60335-2-2:2010+A11:2012+A1:2013
2014/30/EU	EN 55014-1:2017 EN 55014-2:2015 EN 61000-3-2:2014 EN 61000-3-3:2013
2011/65/EU	EN 50581:2012
2009/125/EC 666/2013/EU	EN 60312-1:2017 EN 60704-2-1:2015

Authorized signatory: Pierre Mikaelsson, Executive Vice President, Global Products & Services, Nilfisk NLT

May 11, 2020



HEAD QUARTER

DENMARK

Nilfisk A/S
Kornmarksvej 1
DK-2605 Broendby
Tel.: (+45) 4323 8100
Website: www.nilfisk.com

SALES COMPANIES

ARGENTINA

Nilfisk srl.
Edificio Central Park
Herrera 1855, 6th floor/604
Ciudad de Buenos Aires
Tel.: (+54) 11 6091 1571
Website: www.consumer.nilfisk.com.ar

AUSTRALIA

Nilfisk Pty Ltd
Unit 1/13 Bessemer Street
Blacktown NSW 2148
Tel.: (+61) 2 98348100
Website: www.consumer.nilfisk.com.au

AUSTRIA

Nilfisk GmbH
Metzgerstrasse 68
5101 Bergheim bei Salzburg
Tel.: (+43) 662 456 400 90
Website: www.nilfisk.at

BELGIUM

Nilfisk n.v.s.a.
Riverside Business Park
Boulevard Internationaledaan 55
Bâtiment C3/C4 Gebouw
Bruxelles 1070
Tel.: (+32) 24 67 60 50
Website: www.consumer.nilfisk.be

Brazil

Nilfisk do Brasil
Av. Eng. Luis Carlos Berrini, 550
40 Andar, Sala 03
SP - 04571-000 Sao Paulo
Tel.: (+11) 3959-0300 / 3945-4744
Website: www.nilfisk.com.br

CANADA

Nilfisk Canada Company
240 Superior Boulevard
Mississauga, Ontario L5T 2L2
Tel.: (+1) 800-668-8400
Website: www.nilfisk.ca

CHILE

Nilfisk S.A. (Comercial KCS Ltda)
Salar de Llamara 822
8320000 Santiago
Tel.: (+56) 2684 5000
Website: www.nilfisk.cl

CHINA

Nilfisk
4189 Yindu Road
Xinzhuan Industrial Park
201108 Shanghai
Tel.: (+86) 21 3323 2000
Website: www.nilfisk.cn

CZECH REPUBLIC

Nilfisk s.r.o.
VGP Park Horní Počernice
Do Čertous 1/2658
193 00 Praha 9
Tel.: (+420) 244 090 912
Website: www.consumer.nilfisk.cz

DENMARK

Nilfisk A/S
Kornmarksvej 1
2605 Broendby
Tel.: (+45) 4323 4050
Website: www.consumer.nilfisk.dk

FINLAND

Nilfisk Oy Ab
Koskelontie 23 E
02920 Espoo
Tel.: (+358) 207 890 600
Website: www.consumer.nilfisk.fi

FRANCE

Nilfisk SAS
26 Avenue de la Baltique
Villebon sur Yvette
91978 Courtaubouef Cedex
Tel.: (+33) 169 59 87 24
Website: www.consumer.nilfisk.fr

GERMANY

Nilfisk GmbH
Guido-Oberdorfer-Strasse 2-10
89287 Bellenberg
Tel.: (+49) (0)7306/72-444
Website: www.consumer.nilfisk.de

GREECE

Nilfisk A.E.
Αναπαύσεως 29
Κορωπί Τ.Κ. 194 00

Tel.: (30) 210 9119 600
Website: www.consumer.nilfisk.gr

HOLLAND

Nilfisk B.V.
Versterkerstraat 5
1322 AN Almere
Tel.: (+31) 036 5460760
Website: www.consumer.nilfisk.nl

HONG KONG

Nilfisk Ltd.
2001 HK Worsted Mills
Industrial Building
31-39, Wo Tong Tsui St.
Kwai Chung, N.T.
Tel.: (+852) 2427 5951
Website: www.nilfisk.com

HUNGARY

Nilfisk Kft.
II. Rákóczi Ferenc út 10
2310 Szigetszentmiklós-Lakihegy
Tel.: (+36) 24 475 550
Website: www.nilfisk.hu

INDIA

Nilfisk India Limited
Pramukh Plaza, 'B' Wing, 4th floor, Unit No. 403
Cardinal Gracious Road, Chakala
Andheri (East) Mumbai 400 099
Tel.: (+91) 22 6118 8188
Website: www.nilfisk.in

IRELAND

Nilfisk
1 Stokes Place
St. Stephen's Green
Dublin 2
Tel.: (+35) 3 12 94 38 38
Website: www.nilfisk.ie

ITALY

Nilfisk SpA
Strada Comunale della Braglia, 18
26862 Guardamiglio (LO)
Tel.: (+39) (0) 377 414021
Website: www.nilfisk.it

JAPAN

Nilfisk Inc.
1-6-6 Kita-shinyokohama, Kouhoku-ku
Yokohama, 223-0059
Tel.: (+81) 45548 2571
Website: www.nilfisk.com

MALAYSIA

Nilfisk Sdn Bhd
Sd 33, Jalan KIP 10
Taman Perindustrian KIP
Sri Damansara
52200 Kuala Lumpur
Tel.: +603 6275 3120
Website: www.nilfisk.com

MEXICO

Nilfisk de Mexico, S. de R.L. de C.V.
Pirneos #515 Int.
60-70 Microparque
Industrial WSantiago
76120 Queretaro
Tel.: (+52) (442) 427 77 00
Website: www.nilfisk.com

NEW ZEALAND

Nilfisk Limited
Suite F, Building E
42 Tawa Drive
0632 Albany Auckland
Tel.: (+64) 9 414 1996
Website: www.nilfisk.com

NORWAY

Nilfisk AS
Bjørnerudveien 24
1266 Oslo
Tel.: (+47) 22 75 17 80
Website: www.consumer.nilfisk.no

PERU

Nilfisk S.A.C.
Calle Boulevard 162, Of. 703, Lima 33- Peru
Lima
Tel.: (511) 435-6840
Website: www.nilfisk.com

POLAND

Nilfisk Sp. Z.O.O.
Millenium Logistic Park
ul. 3 Maja 8, Bud. B4
05-800 Pruszków
Tel.: (+48) 22 738 3750
Website: www.consumer.nilfisk.pl

PORTUGAL

Nilfisk Lda.
Sintra Business Park
Zona Industrial Da Abrunheira
Edifício 1, 1º A
P2710-089 Sintra
Tel.: (+351) 21 911 2670
Website: www.nilfisk.pt

RUSSIA

Nilfisk LLC

Vyatskaya str. 27, bld. 7/1st
127015 Moscow
Tel.: (+7) 495 783 9602
Website: www.consumer.nilfisk.ru

SINGAPORE

Den-Sin
22 Tuas Avenue 2
639453 Singapore
Tel.: (+65) 6268 1006
Website: www.densin.com

SLOVAKIA

Nilfisk s.r.o.
Bancíkovej 1/A
SK-821 03 Bratislava
Tel.: (+421) 910 222 928
Website: www.consumer.nilfisk.sk

SOUTH AFRICA

Nilfisk (Pty) Ltd
Kimbulk Office Park, 9 Zeiss Road
Laser Park, Honeydew
Johannesburg
Tel.: (+27) 118014600
Website: www.nilfisk.co.za

SOUTH KOREA

Nilfisk Korea
3F Duksoo B/D. 317-15
Sungsoo-Dong 2Ga
Sungdong-Gu, Seoul
Tel.: (+82) 2497 8636
Website: www.nilfisk.co.kr

SPAIN

Nilfisk S.A.U
Paseo del Rengle, 5 Planta. 9-10
08302 Mataró
Tel.: (+34) 93 741 2400
Website: www.consumer.nilfisk.es

SWEDEN

Nilfisk AB
Taljegårdsgatan 4
431 53 Mölndal
Tel.: (+46) 31 706 73 00
Website: www.consumer.nilfisk.se

SWITZERLAND

Nilfisk AG
Ringstrasse 19
Kircheberg/Industri Stelz
9500 Wil
Tel.: (+41) 71 92 38 444
Website: www.consumer.nilfisk.ch

TAIWAN

Nilfisk Ltd
Taiwan Branch (H.K)
No. 5, Wan Fang Road
Taipei
Tel.: (+88) 6227 00 22 68
Website: www.nilfisk.tw

THAILAND

Nilfisk Co. Ltd.
89 Soi Chokechai-Ruammitr
Viphavadee-Rangsit Road
Ladyao, Jatuchak, Bangkok 10900
Tel.: (+66) 2275 5630
Website: www.nilfisk.co.th

TURKEY

Nilfisk A.S.
Serifali Mh. Bayraktar Bulv. Sehit Sk. No:7
Ümraniye, 34775 Istanbul
Tel.: +90 216 466 94 94
Website: www.consumer.nilfisk.com.tr

UNITED ARAB EMIRATES

Nilfisk Middle East Branch
SAIF-Zone
P.O. Box 122298
Sharjah
Tel.: (+971) (0) 655-78813
Website: www.nilfisk.com

UNITED KINGDOM

Nilfisk Ltd.
Nilfisk House, Bowerbank Way
Gillwily Industrial Estate, Penrith
Cumbria CA11 9BQ
Tel.: (+44) (0) 1768 868995
Website: www.consumer.nilfisk.co.uk

UNITED STATES

Nilfisk Inc.
14600 21st Avenue North
Plymouth, MN-55447
Tel.: (+1) 800-989-2235
Website: www.nilfisk.com

VIETNAM

Nilfisk Vietnam
No. 51 Doc Ngu Str.
P. Vinh Phuc, Q.Ba Dinh
Hanoi
Tel.: (+84) 761 5642
Website: www.nilfisk.com

