



# One

















## Instruções de operação















## Instruções de segurança

-  Leia este manual atentamente antes de utilizar o aparelho pela primeira vez. Guarde as instruções para utilizações posteriores.
- 

### Avisos !

-  Não utilize o aparelho sem que o respetivo saco e filtros estejam devidamente colocados.
-  Não utilize o aparelho para aspirar materiais perigosos ou gases. Se o fizer poderá estar a colocar pessoas em risco de saúde grave.
-  Não utilize o aparelho para aspirar água ou outros líquidos.
-  Não aspire objetos pontiagudos ou cortantes, tais como agulhas ou pedaços de vidro.
-  Não aspire nada que esteja em combustão como, por exemplo, cigarros, fósforos ou cinzas quentes.
-  Utilize e guarde o aparelho em espaços interiores e em ambientes secos, entre os 0 °C e os 60 °C.
-  Não utilize o aparelho no exterior.
-  É necessário cuidado ao utilizar a função de enrolador de cabo, uma vez que a ficha na extremidade do cabo elétrico pode virar subitamente durante a última parte do processo. É aconselhável segurar o cabo enquanto este está a ser enrolado.
-  Não manuseie o aparelho com as mãos molhadas.
-  Desligue o aparelho antes de o desligar da corrente.
-  Para desligar o aparelho da corrente, puxe a ficha, não o cabo. Não transporte ou puxe o aparelho pelo cabo.
-  Não utilize o aparelho se o cabo estiver danificado. Inspeccione regularmente o cabo quanto a danos, especialmente se o cabo tiver sido comprimido, entalado numa porta ou pisado.
-  Não utilize o aparelho se este parecer danificado. Submeta o aparelho a uma inspeção num centro de assistência técnica caso este tenha caído, esteja danificado, tenha ficado no exterior ou tenha sido exposto a água.
-  Não faça alterações ou modificações aos dispositivos de segurança mecânicos ou elétricos.
-  Todas as reparações devem ser efetuadas por um centro de assistência técnica autorizado.
-  Utilize apenas sacos, filtros e acessórios originais do seu distribuidor local. A utilização de sacos e filtros não autorizados anula a garantia.
-  Desligue o aparelho no botão e na tomada antes de trocar o saco ou o filtro. Puxe a ficha, não o cabo.

-  Se o cabo de alimentação estiver danificado, o mesmo tem de ser substituído pelo fabricante, pelo seu fornecedor ou técnico igualmente qualificado a fim de evitar riscos.
-  Não toque em peças em rotação ao utilizar o bocal turbo.
-  Este aparelho pode ser utilizado por crianças a partir dos 8 anos de idade e por pessoas com capacidades físicas, sensoriais ou mentais reduzidas ou sem experiência, caso estas sejam supervisionadas ou lhes seja indicado como utilizar o aparelho em segurança e se estas compreenderem os riscos envolvidos.
-  Não deixe que crianças procedam à limpeza do aparelho ou executem a sua manutenção sem supervisão.
-  As crianças têm de ser supervisionadas para que não haja a possibilidade de brincarem com o aparelho.
-  Não carregue pilhas não recarregáveis.
-  Remova as pilhas recarregáveis do aparelho antes do carregamento.
-  Não misture diferentes tipos de pilhas ou pilhas novas e usadas.
-  Tome atenção à polaridade correta ao introduzir as pilhas.
-  Remova pilhas descarregadas do aparelho e elimine-as de forma segura.
-  Se não utilizar o aparelho durante um longo período de tempo, remova as pilhas.
-  Não coloque os terminais de alimentação em curto-circuito.

### Assistência e manutenção

Armazene o aparelho num espaço interior e em ambiente seco.

- Mude o pré-filtro a cada quatro sacos.
- Limpe a superfície da máquina com um pano seco ou ligeiramente humedecido com produto de limpeza.
- Compre acessórios originais num distribuidor local.
- Para obter assistência, contacte apenas o seu distribuidor local.

### Responsabilidade

A Nilfisk não se responsabiliza por quaisquer danos resultantes de uma utilização incorreta ou de modificações efetuadas ao aparelho. Consulte o nosso site em [www.nilfisk.com](http://www.nilfisk.com) para obter mais instruções e informações sobre a utilização.

**WEEE**



O símbolo  indica que este aparelho não pode ser eliminado em conjunto com o lixo doméstico, mas em separado. Elimine os seus aparelhos antigos colocando-os nos pontos de recolha de reciclagem.

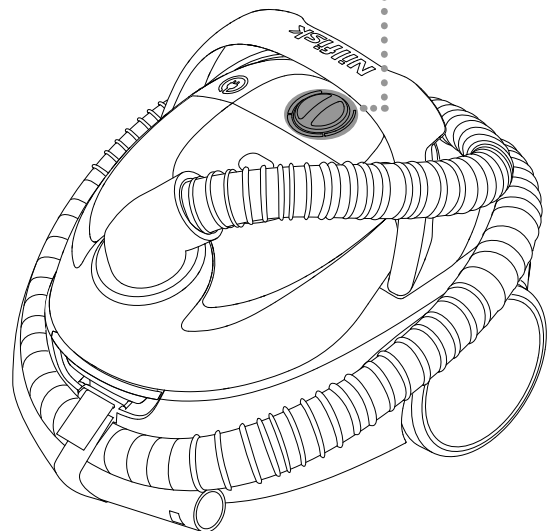
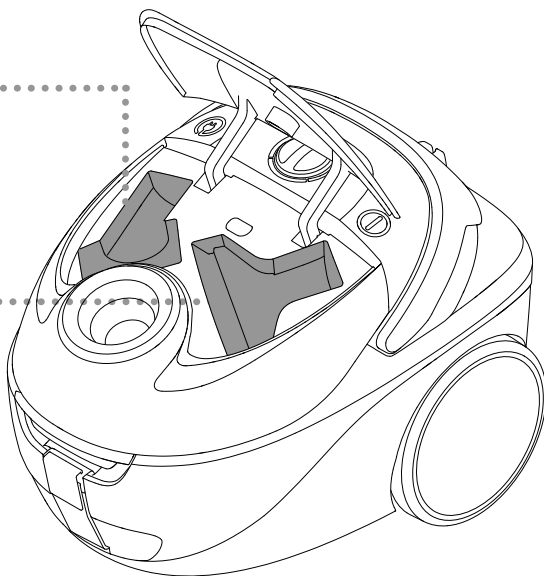
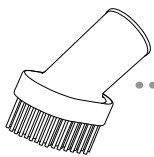
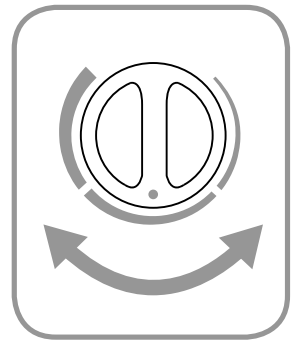
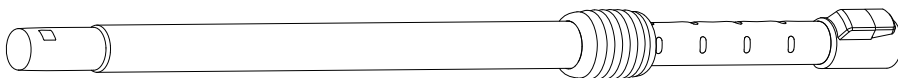
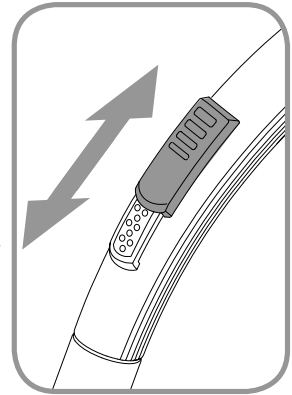
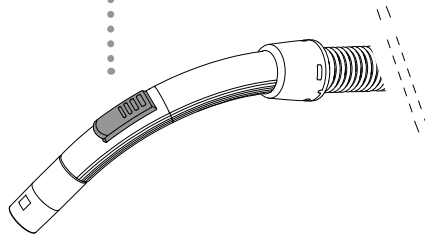
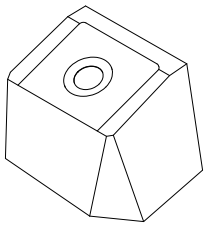
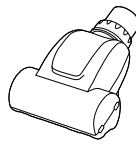
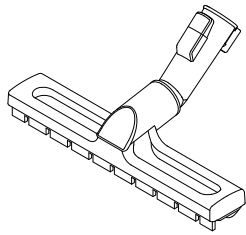
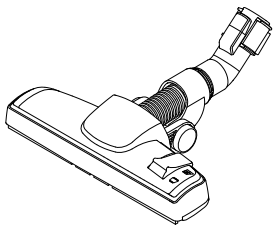

Os tipos de bocais incluídos pode variar de modelo para modelo.

A 

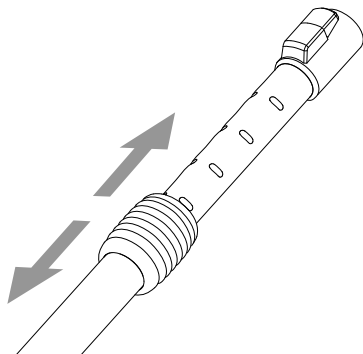
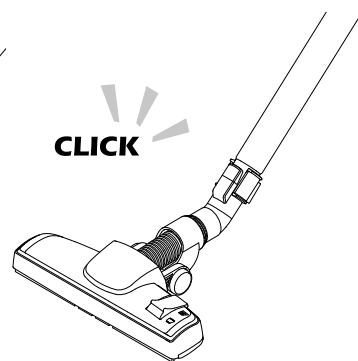
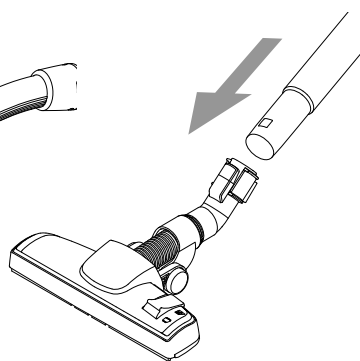
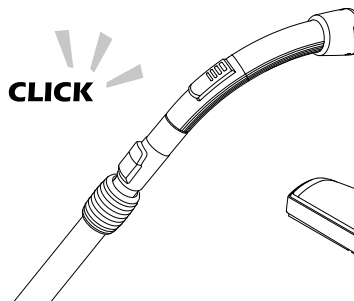
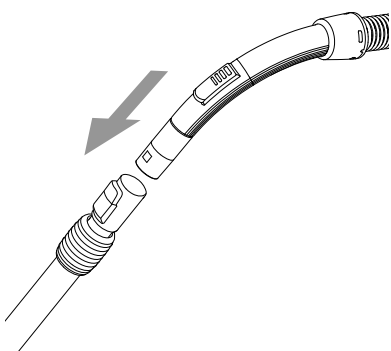
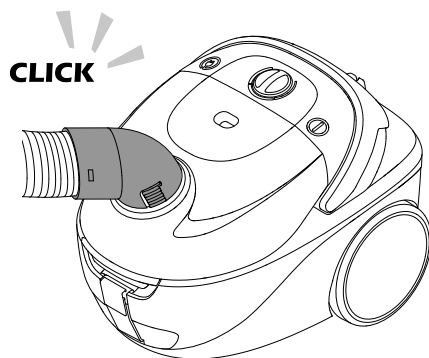
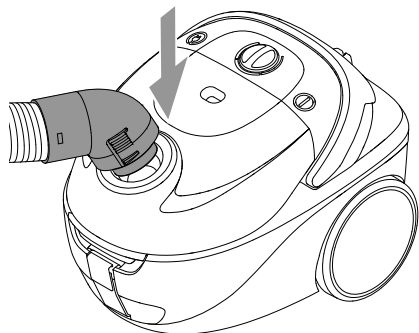

B 

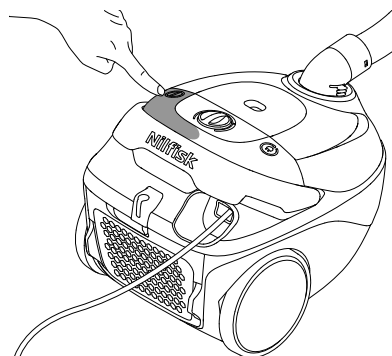
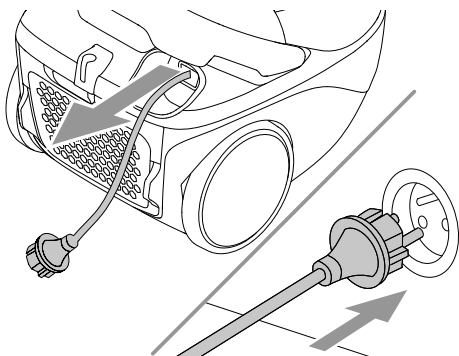

C 

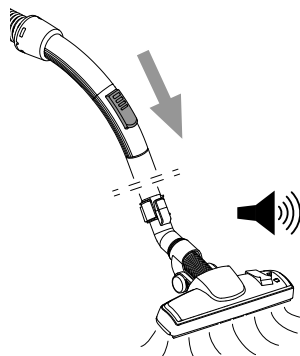
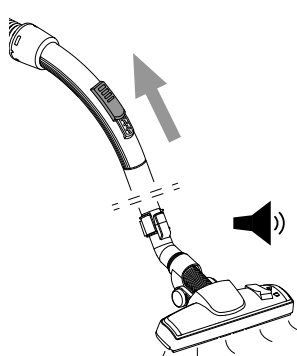
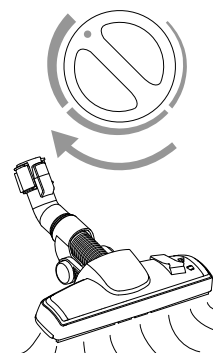
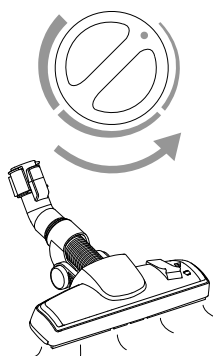
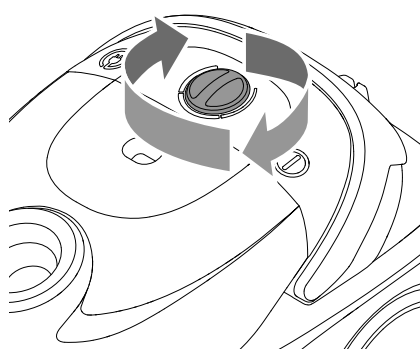

D 

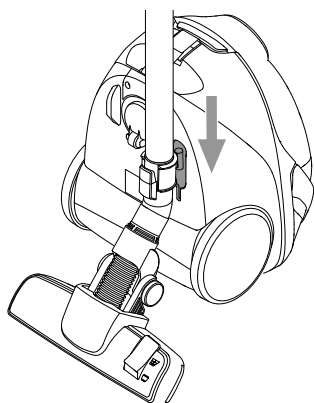
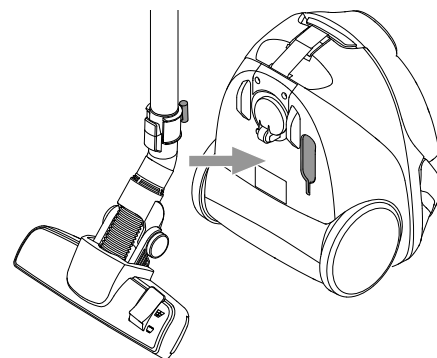
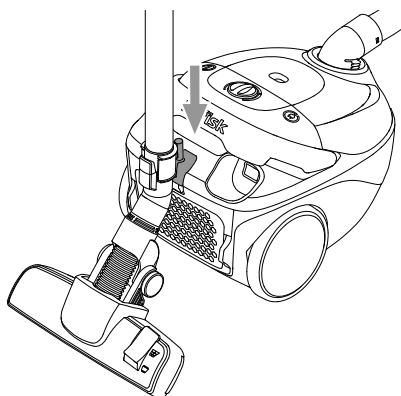
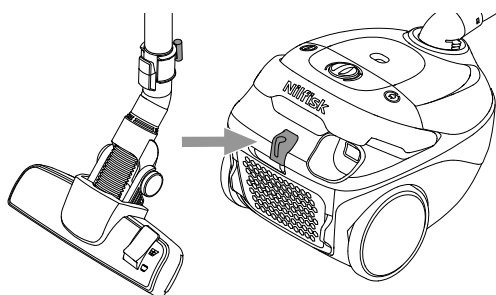

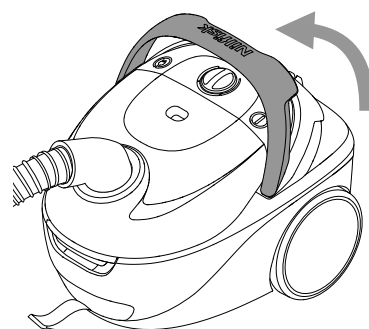
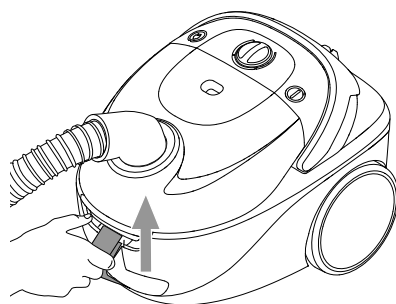
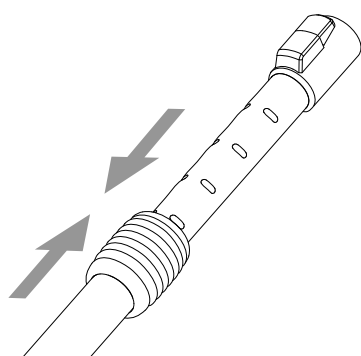
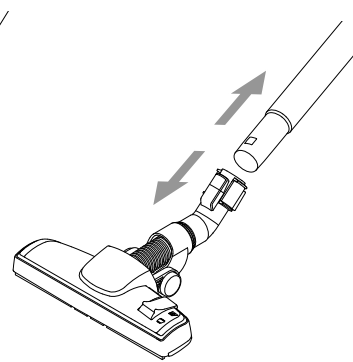
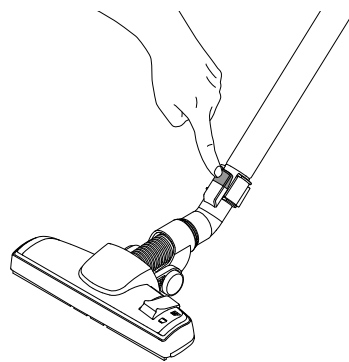
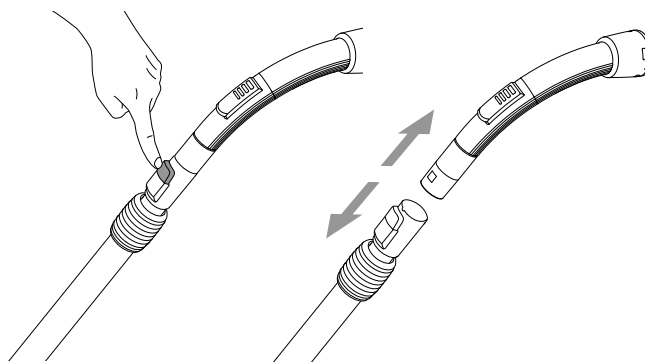
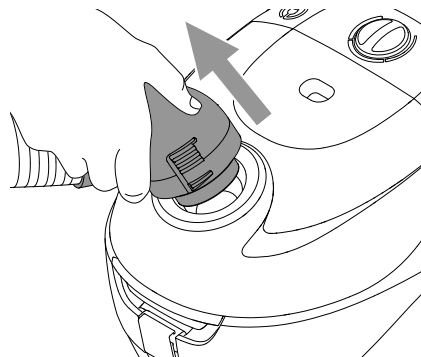
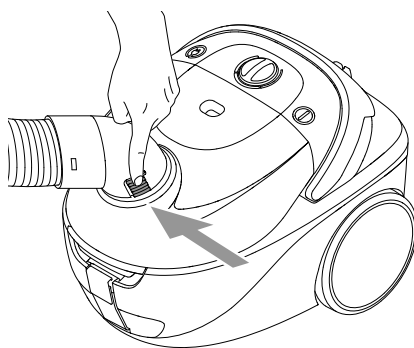
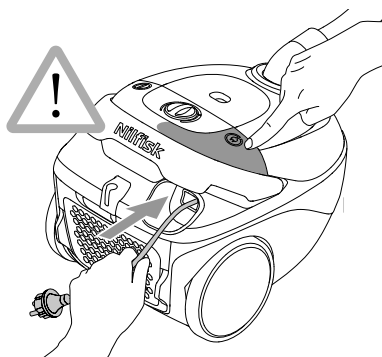
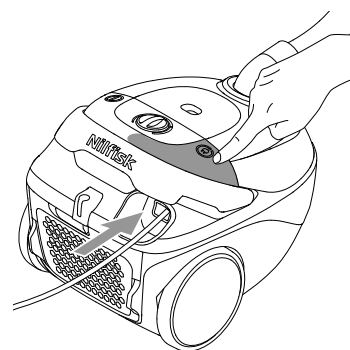
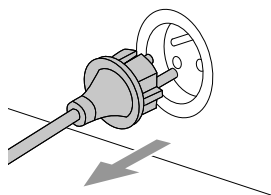
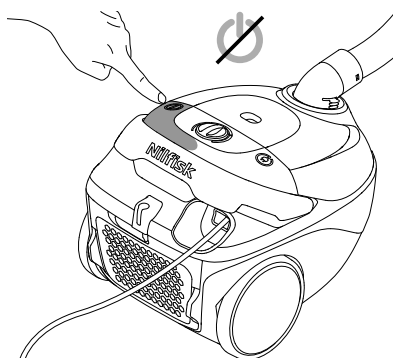

E

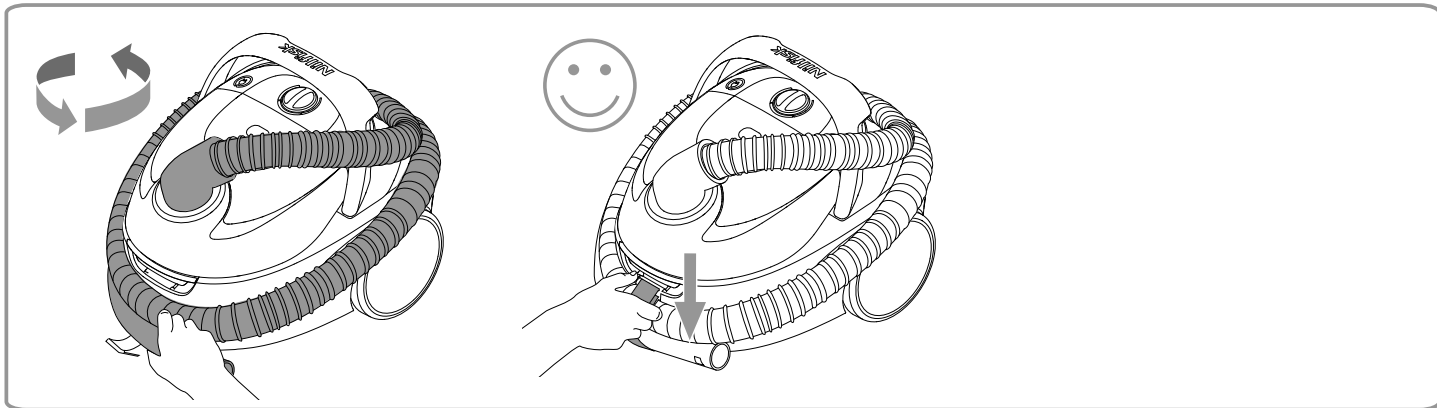

F

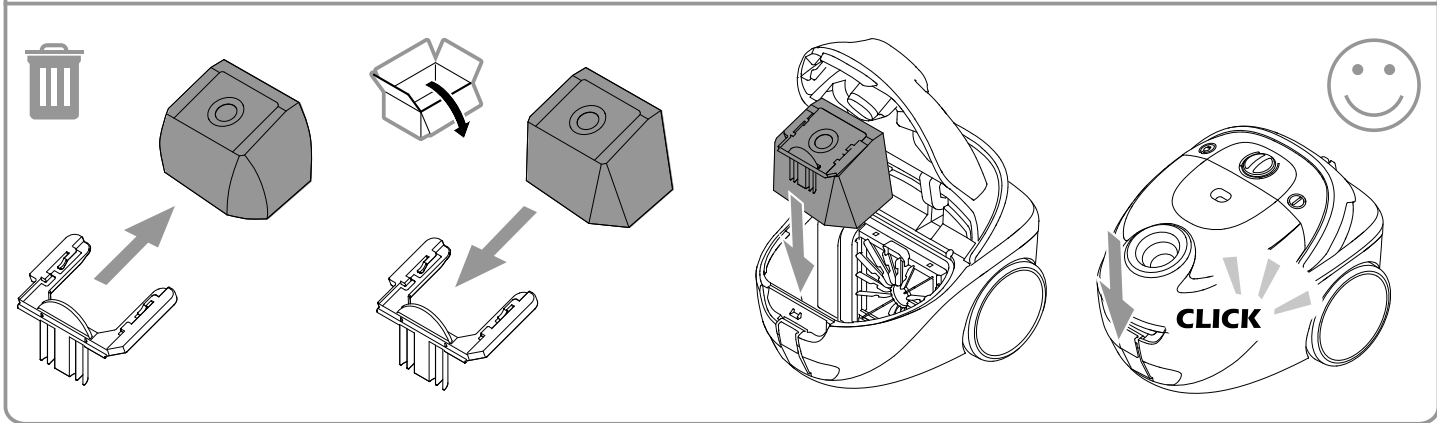
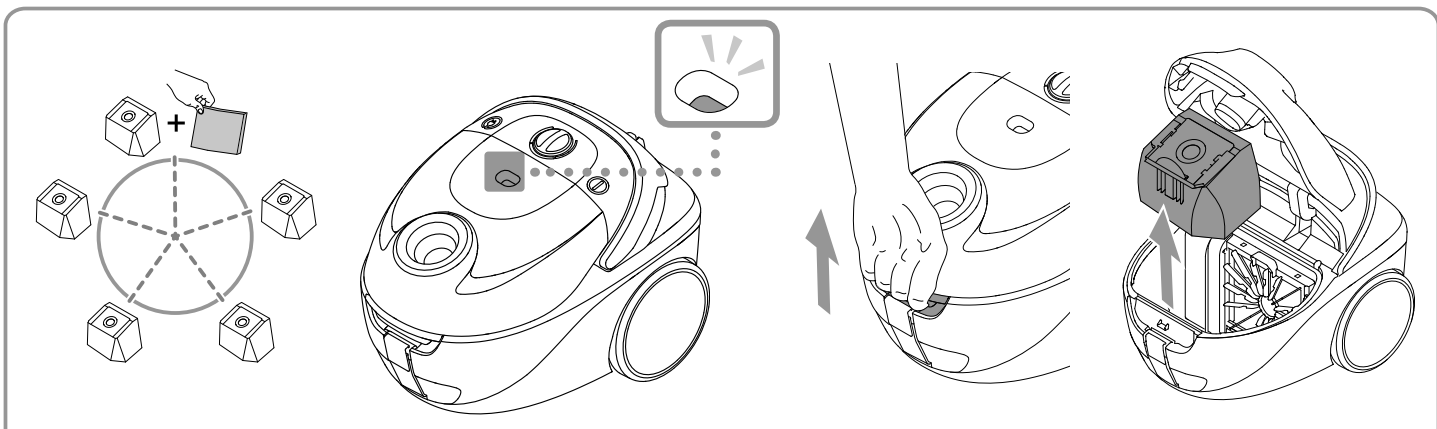

G

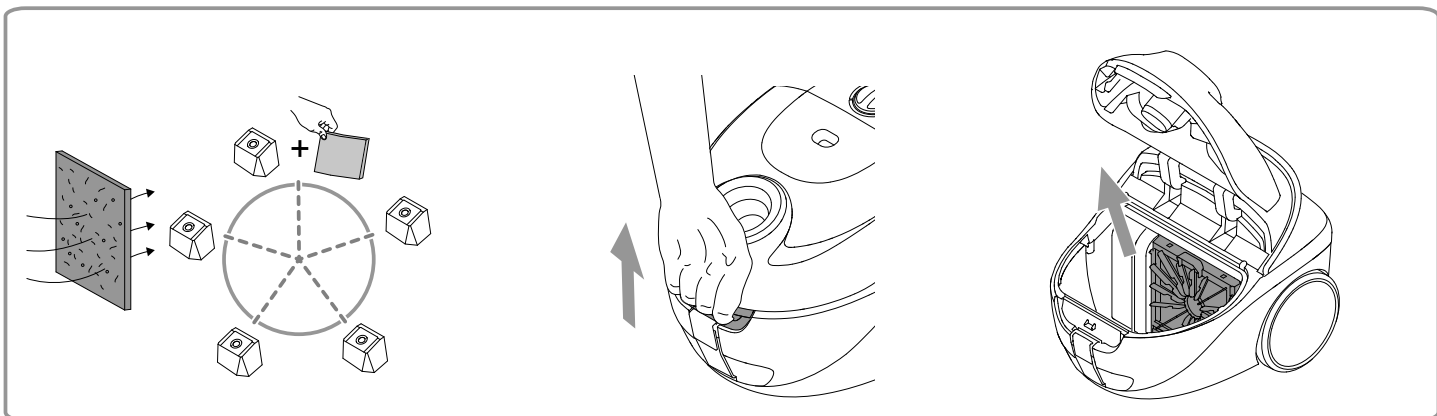

G

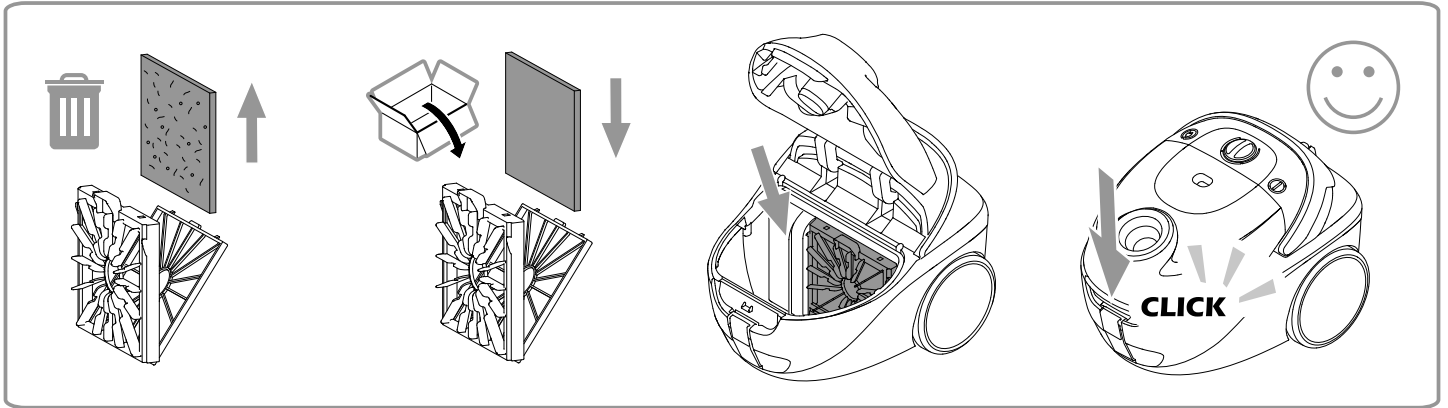

H

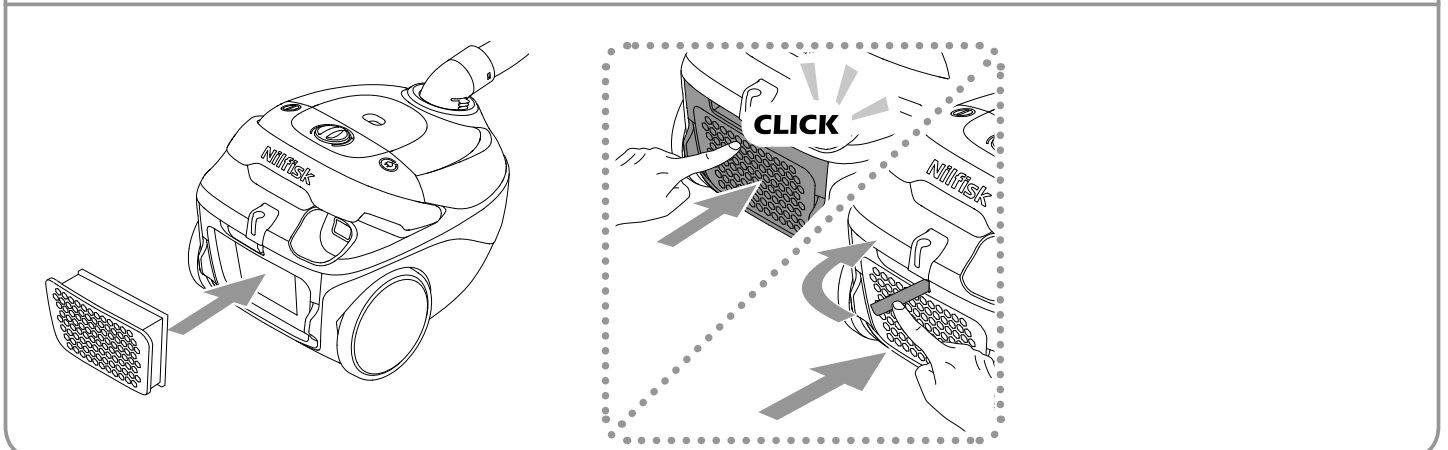
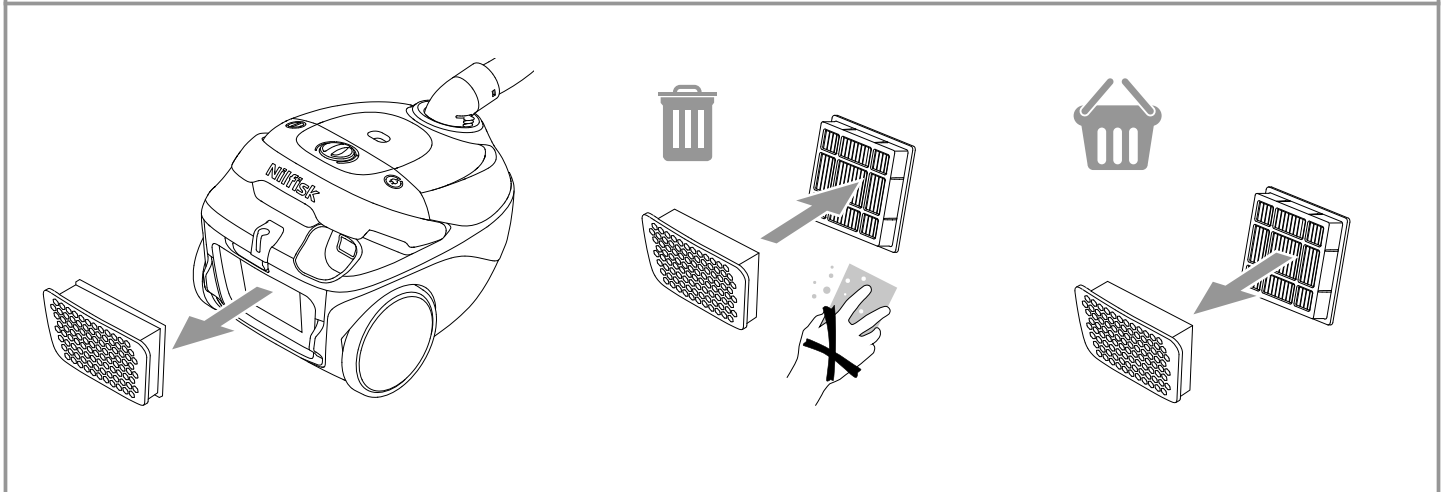
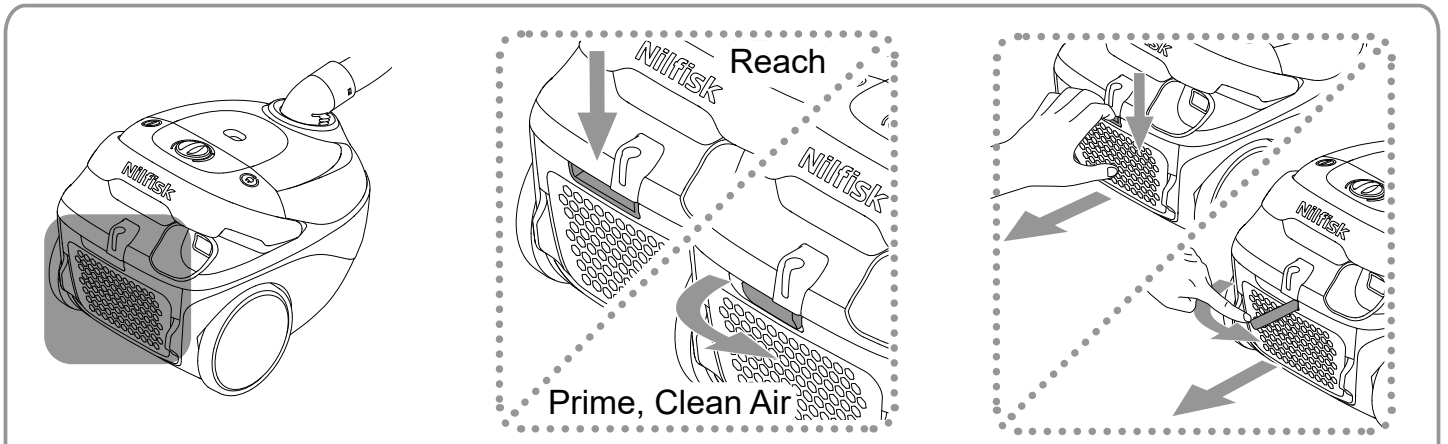

I 

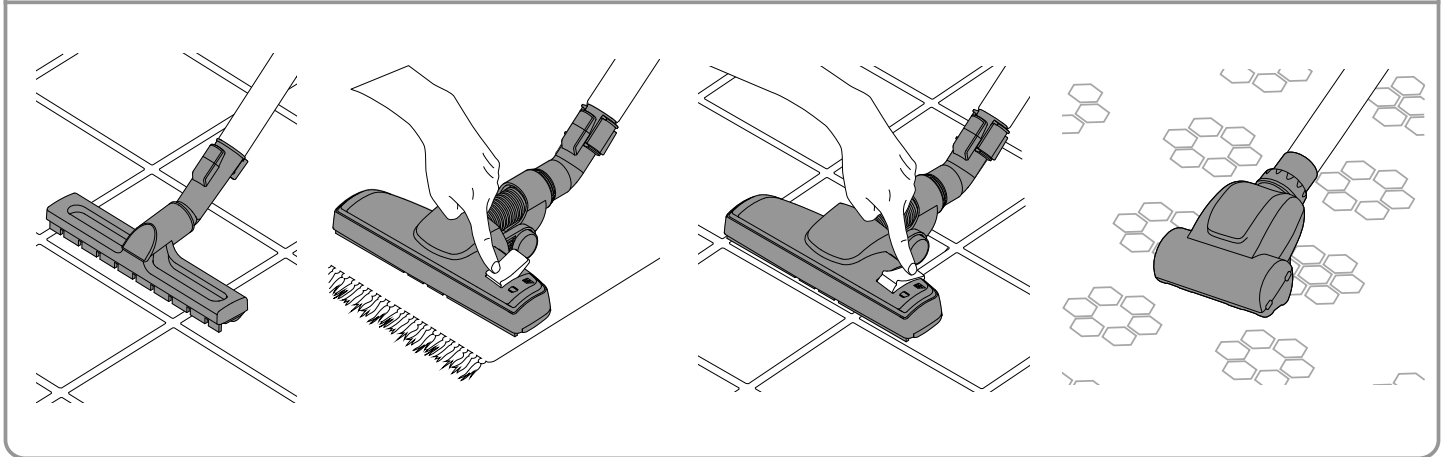
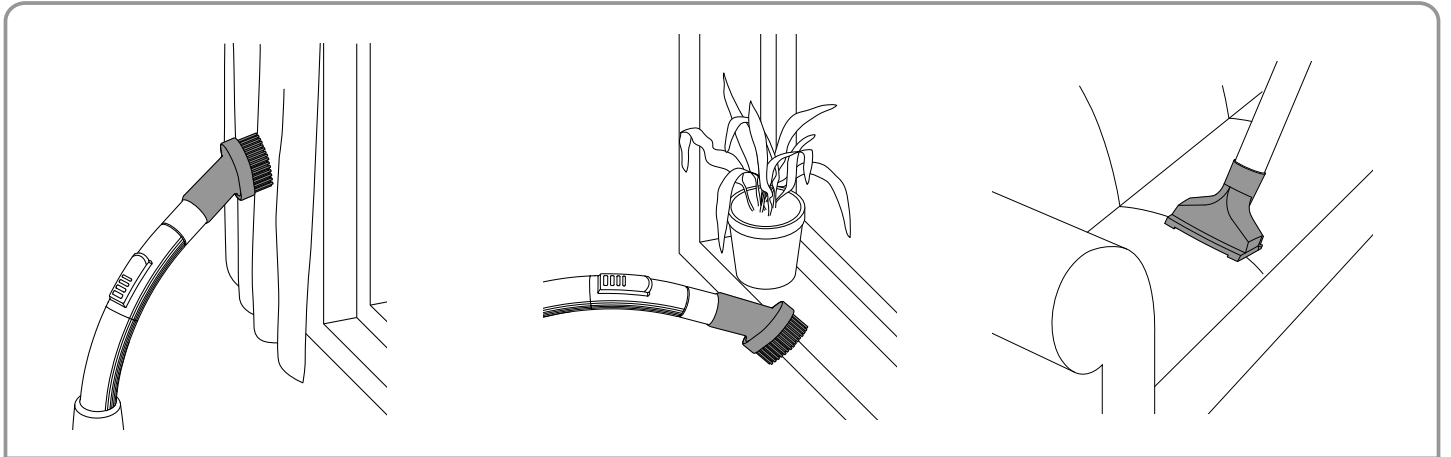

J 

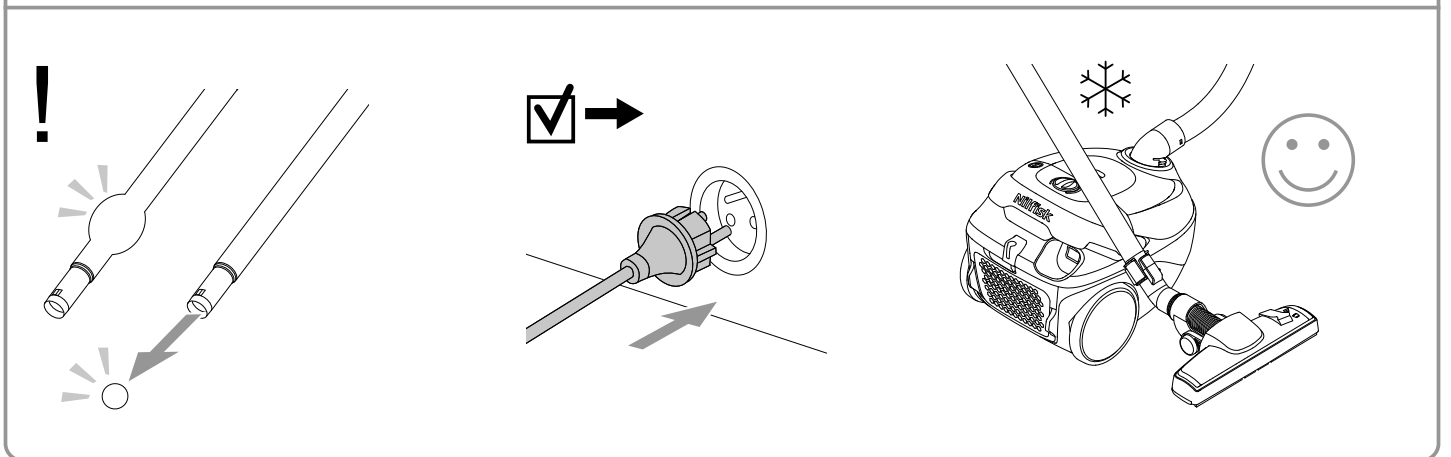
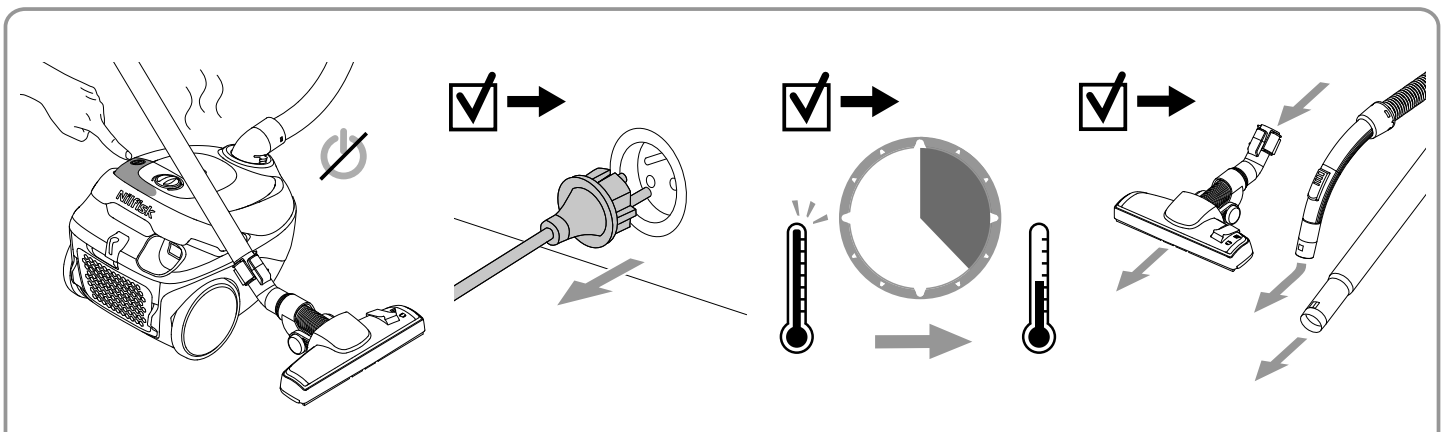

# K

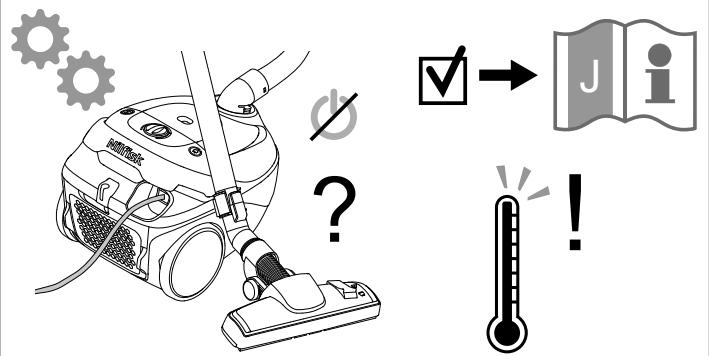
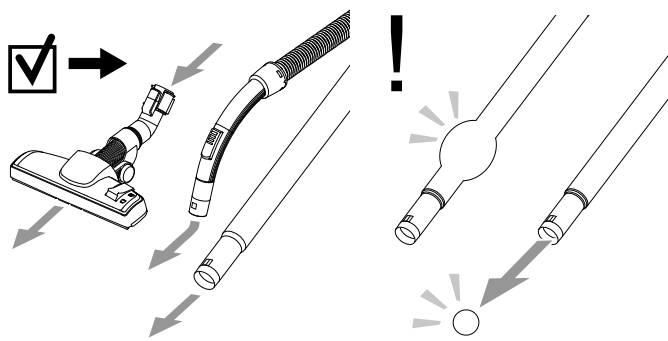
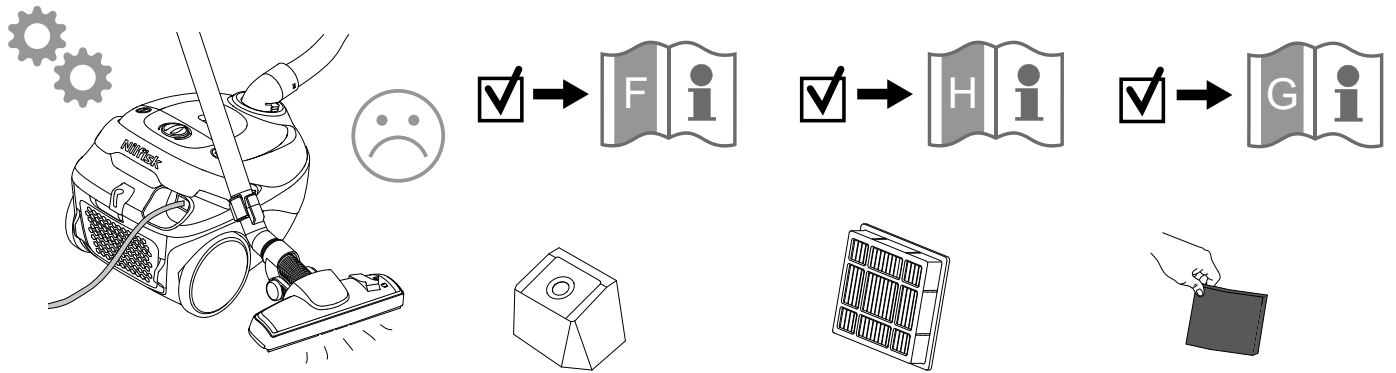

# L

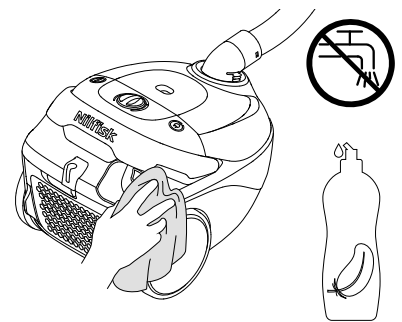
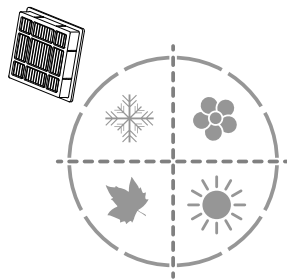
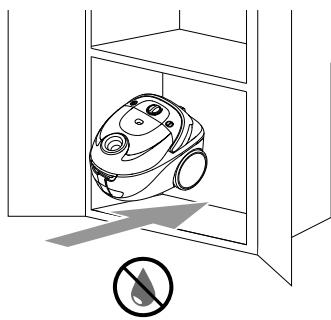



EU / UE / EL / EC / EE / ES / EÚ / AB

**Declaration of Conformity**

Prohlášení o shodě  
Konformitätserklärung  
Overensstemmelseserklæring  
Declaración de conformidad  
Vastavusdeklaratsioon  
Déclaration de conformité  
Vaatumustenmukaisuusvakuutus

Декларация за съответствие  
Δήλωση συμμόρφωσης  
Megfelelősségi nyilatkozat  
Izjava o skladnosti  
Dichiarazione di conformità  
Atitikties deklaracija  
Atbilstības deklarācija  
Samsvarserklæring  
Conformiteitsverklaring

Declaração de conformidade  
Declaracja zgodności  
Declaratie de conformitate  
Декларация о соответствии  
Försäkran om överensstämmelse  
Vyhlásenie o zhode  
Izjava o skladnosti  
Uygunluk beyanı

**Manufacturer /** Výrobce / Hersteller / Fabrikant / Fabricante / Κατασκευαστής /  
Gyártó / Proizvođač / Fabbicante / Gamintojas / Ražotājs / Produzent / Fabrikant /  
Fabricante / Producent / Producător / производитель / Tillverkaren / Výrobca /  
Proizvajalec / Üretici firma:

**Nilfisk A/S, Kornmarksvej 1  
DK-2605 Broendby, DENMARK**

**Product /** Produkt / Producto, Toode, Produit, Tuote / Продукт /  
Προϊόν / Termék / Proizvod / Prodotto / Produktas / Produkts /  
Artikel / Produtos / Prods / Izdelek / Ürün

**One Performance Basic\*, One Energy Basic\*, One  
Performance Prime\*, where \* means Country  
Code**

**Description /** Popis / Beschreibung / Beskrivelse / Descripción /  
Kirjeldus / La description / Kuvaus / Описание / Περιγραφή / Leirás /  
Opis / Descrizione / Aprašymas / Apraksts / Beschrijving / Descrição /  
Descriere / Beskrivning / Popis / Açıklama

**VAC - Consumer - Dry  
220-240V 50-60Hz, IPX0**

- |   |   |   |
|---|---|---|
| <b>EN</b> We, Nilfisk hereby declare under our sole responsibility, that the above-mentioned product(s) is/are in conformity with the following directives and standards. | <b>BG</b> Ние, Nilfisk С настоящото декларираме на своя лична отговорност, че посочените по-горе продуктът е в съответствие със следните директиви и стандарти. | <b>PT</b> Nós, a Nilfisk declaramos, sob nossa exclusiva responsabilidade, que o produto acima mencionado está em conformidade com as diretrizes e normas a seguir. |
| <b>CS</b> My, Nilfisk prohlašujeme na svou výlučnou odpovědnost, že výše uvedený výrobek je ve shodě s následujícími směrnici a normami.                                  | <b>EL</b> Εμείς, Nilfisk δηλώνουμε με αποκλειστική μας ευθύνη, ότι το προαναφερόμενο προϊόν συμμορφώνεται με τις ακόλουθες οδηγίες και πρότυπα.                 | <b>PL</b> My, Nilfisk Niniejszym oświadczamy z pełną odpowiedzialnością, że wyżej wymieniony produkt jest zgodny z następującymi dyrektywami i normami.             |
| <b>DE</b> Wir, Nilfisk erklären in alleiniger Verantwortung, dass das oben genannte Produkt den folgenden Richtlinien und Normen entspricht.                              | <b>HU</b> Mi, Nilfisk kijelentjük, egyedüli felelősséggel, hogy a fent említett termék megfelel az alábbi irányelveknek és szabványoknak                        | <b>RO</b> Noi, Nilfisk Prin prezenta declarăm pe propria răspundere, că produsul mai sus menționat este în conformitate cu următoarele standarde și directive.      |
| <b>DA</b> Vi, Nilfisk erklærer hermed under eget ansvar at ovennævnte produkt(er) er i overensstemmelse med følgende direktiver og standarder.                            | <b>HR</b> Mi, Nilfisk izjavljujemo pod punom odgovornošću, da gore navedeni proizvod u skladu sa sljedećim direktivama i standardima.                           | <b>RU</b> Мы, Nilfisk настоящим заявляем под нашу полную ответственность, что вышеперечисленные продукция соответствует следующими директивам и стандартам.         |
| <b>ES</b> Nosotros, Nilfisk declaramos bajo nuestra única responsabilidad que el producto antes mencionado está en conformidad con las siguientes directivas y normas     | <b>IT</b> Noi, Nilfisk dichiara sotto la propria responsabilità, che il prodotto di cui sopra è conforme alle seguenti direttive e norme.                       | <b>SV</b> Vi Nilfisk förklarar härmed under eget ansvar att ovan nämnda produkt överensstämmer med följande direktiv och normer.                                    |
| <b>ET</b> Meie, Nilfisk Käesolevaga kinnitame ja kanname ainusikulist vastutust, et eespool nimetatud toode on kooskõlas järgmiste direktiivide ja                        | <b>LT</b> Mes, "Nilfisk pareiškiu vienašališkos atsakomybės, kad pirmiau minėtas produkts atitinka šias direktyvas ir standartus                                | <b>SK</b> My, Nilfisk prehlasujeme na svoju výlučnú zodpovednosť, že vyššie uvedený výrobok je v zhode s nasledujúcimi smernicami a normami.                        |
| <b>FR</b> Nilfisk déclare sous notre seule responsabilité que le produit mentionné ci-dessus est conforme aux directives et normes suivantes.                             | <b>LV</b> Mēs, Nilfisk šo apliecinu ar pilnu atbildību, ka iepriekš minētais produkts atbilst šādām direktīvām un standartiem                                   | <b>SL</b> Mi, Nilfisk izjavljamo s polno odgovornostjo, da je zgoraj omenjeni izdelek v skladu z naslednjimi smernicami in standardi.                               |
| <b>FI</b> Me, Nilfisk täten vakuutamme omalla vastuulla, että edellä mainittu tuote on yhdenmukainen seuraavien direktiivien ja standardien mukaisesti                    | <b>NO</b> Vi, Nilfisk erklærer herved under eget ansvar, at det ovennevnte produktet er i samsvar med følgende direktiver og standarder                         | <b>TR</b> Nilfisk, burada yer alan tüm sorumluluklarımızı göze, yukarıda belirtilen ürünün aşağıdaki direktifler ve standartlara uygun olduğunu beyan ederiz.       |
| <b>NL</b> We verklaren Nilfisk hierbij op eigen verantwoordelijkheid, dat het bovengenoemde product voldoet aan de volgende richtlijnen en normen                         |   |   |

2014/35/EU	EN 60335-1:2012+A11:2014+A13:2017+A1:2019+A2:2019+A14:2019 EN 60335-2-2:2010+A11:2012+A1:2013
2014/30/EU	EN 55014-1:2017 EN 55014-2:2015 EN 61000-3-2:2014 EN 61000-3-3:2013
2011/65/EU	EN 50581:2012
2009/125/EC 666/2013/EU	EN 60312-1:2017 EN 60704-2-1:2015

Authorized signatory: Pierre Mikaelsson, Executive Vice President, Global Products & Services, Nilfisk NLT

May 11, 2020



## HEAD QUARTER

### DENMARK

Nilfisk A/S  
Kornmarksvej 1  
DK-2605 Broendby  
Tel.: (+45) 4323 8100  
Website: www.nilfisk.com

## SALES COMPANIES

### ARGENTINA

Nilfisk srl.  
Edificio Central Park  
Herrera 1855, 6th floor/604  
Ciudad de Buenos Aires  
Tel.: (+54) 11 6091 1571  
Website: www.consumer.nilfisk.com.ar

### AUSTRALIA

Nilfisk Pty Ltd  
Unit 1/13 Bessemer Street  
Blacktown NSW 2148  
Tel.: (+61) 2 98348100  
Website: www.consumer.nilfisk.com.au

### AUSTRIA

Nilfisk GmbH  
Metzgerstrasse 68  
5101 Bergheim bei Salzburg  
Tel.: (+43) 662 456 400 90  
Website: www.nilfisk.at

### BELGIUM

Nilfisk n.v.s.a.  
Riverside Business Park  
Boulevard Internationaaleaan 55  
Bâtiment C3/C4 Gebouw  
Bruxelles 1070  
Tel.: (+32) 24 67 60 50  
Website: www.consumer.nilfisk.be

### Brazil

Nilfisk do Brasil  
Av. Eng. Luis Carlos Berrini, 550  
40 Andar, Sala 03  
SP - 04571-000 Sao Paulo  
Tel.: (+11) 3959-0300 / 3945-4744  
Website: www.nilfisk.com.br

### CANADA

Nilfisk Canada Company  
240 Superior Boulevard  
Mississauga, Ontario L5T 2L2  
Tel.: (+1) 800-668-8400  
Website: www.nilfisk.ca

### CHILE

Nilfisk S.A. (Comercial KCS Ltda)  
Salar de Llamara 822  
8320000 Santiago  
Tel.: (+56) 2684 5000  
Website: www.nilfisk.cl

### CHINA

Nilfisk  
4189 Yindu Road  
Xinzhuang Industrial Park  
201108 Shanghai  
Tel.: (+86) 21 3323 2000  
Website: www.nilfisk.cn

### CZECH REPUBLIC

Nilfisk s.r.o.  
VGP Park Horní Počernice  
Do Čertous 1/2658  
193 00 Praha 9  
Tel.: (+420) 244 090 912  
Website: www.consumer.nilfisk.cz

### DENMARK

Nilfisk A/S  
Kornmarksvej 1  
2605 Broendby  
Tel.: (+45) 4323 4050  
Website: www.consumer.nilfisk.dk

### FINLAND

Nilfisk Oy Ab  
Koskelontie 23 E  
02920 Espoo  
Tel.: (+358) 207 890 600  
Website: www.consumer.nilfisk.fi

### FRANCE

Nilfisk SAS  
26 Avenue de la Baltique  
Villebon sur Yvette  
91978 Courtaubouef Cedex  
Tel.: (+33) 169 59 87 24  
Website: www.consumer.nilfisk.fr

### GERMANY

Nilfisk GmbH  
Guido-Oberdorfer-Strasse 2-10  
89287 Bellenberg  
Tel.: (+49) (0)7306/72-444  
Website: www.consumer.nilfisk.de

### GREECE

Nilfisk A.E.  
Αναπαύσεως 29  
Κορωπί Τ.Κ. 194 00

Tel.: (30) 210 9119 600  
Website: www.consumer.nilfisk.gr

### HOLLAND

Nilfisk B.V.  
Versterkerstraat 5  
1322 AN Almere  
Tel.: (+31) 036 5460760  
Website: www.consumer.nilfisk.nl

### HONG KONG

Nilfisk Ltd.  
2001 HK Worsted Mills  
Industrial Building  
31-39, Wo Tong Tsui St.  
Kwai Chung, N.T.  
Tel.: (+852) 2427 5951  
Website: www.nilfisk.com

### HUNGARY

Nilfisk Kft.  
II. Rákóczi Ferenc út 10  
2310 Szigetszentmiklós-Lakihegy  
Tel.: (+36) 24 475 550  
Website: www.nilfisk.hu

### INDIA

Nilfisk India Limited  
Pramukh Plaza, 'B' Wing, 4th floor, Unit No. 403  
Cardinal Gracious Road, Chakala  
Andheri (East) Mumbai 400 099  
Tel.: (+91) 22 6118 8188  
Website: www.nilfisk.in

### IRELAND

Nilfisk  
1 Stokes Place  
St. Stephen's Green  
Dublin 2  
Tel.: (+35) 3 12 94 38 38  
Website: www.nilfisk.ie

### ITALY

Nilfisk SpA  
Strada Comunale della Braglia, 18  
26862 Guardamiglio (LO)  
Tel.: (+39) (0) 377 414021  
Website: www.nilfisk.it

### JAPAN

Nilfisk Inc.  
1-6-6 Kita-shinyokohama, Kouhoku-ku  
Yokohama, 223-0059  
Tel.: (+81) 45548 2571  
Website: www.nilfisk.com

### MALAYSIA

Nilfisk Sdn Bhd  
Sd 33, Jalan KIP 10  
Taman Perindustrian KIP  
Sri Damansara  
52200 Kuala Lumpur  
Tel.: +603 6275 3120  
Website: www.nilfisk.com

### MEXICO

Nilfisk de Mexico, S. de R.L. de C.V.  
Pirneos #515 Int.  
60-70 Microparque  
Industrial WSantiago  
76120 Queretaro  
Tel.: (+52) (442) 427 77 00  
Website: www.nilfisk.com

### NEW ZEALAND

Nilfisk Limited  
Suite F, Building E  
42 Tawa Drive  
0632 Albany Auckland  
Tel.: (+64) 9 414 1996  
Website: www.nilfisk.com

### NORWAY

Nilfisk AS  
Bjørnerudveien 24  
1266 Oslo  
Tel.: (+47) 22 75 17 80  
Website: www.consumer.nilfisk.no

### PERU

Nilfisk S.A.C.  
Calle Boulevard 162, Of. 703, Lima 33- Peru  
Lima  
Tel.: (511) 435-6840  
Website: www.nilfisk.com

### POLAND

Nilfisk Sp. Z.O.O.  
Millenium Logistic Park  
ul. 3 Maja 8, Bud. B4  
05-800 Pruszków  
Tel.: (+48) 22 738 3750  
Website: www.consumer.nilfisk.pl

### PORTUGAL

Nilfisk Lda.  
Sintra Business Park  
Zona Industrial Da Abrunheira  
Edifício 1, 1º A  
P2710-089 Sintra  
Tel.: (+351) 21 911 2670  
Website: www.nilfisk.pt

### RUSSIA

Nilfisk LLC

Vyatskaya str. 27, bld. 7/1st  
127015 Moscow  
Tel.: (+7) 495 783 9602  
Website: www.consumer.nilfisk.ru

### SINGAPORE

Den-Sin  
22 Tuas Avenue 2  
639453 Singapore  
Tel.: (+65) 6268 1006  
Website: www.densin.com

### SLOVAKIA

Nilfisk s.r.o.  
Bancíkovej 1/A  
SK-821 03 Bratislava  
Tel.: (+421) 910 222 928  
Website: www.consumer.nilfisk.sk

### SOUTH AFRICA

Nilfisk (Pty) Ltd  
Kimbul Office Park, 9 Zeiss Road  
Laser Park, Honeydew  
Johannesburg  
Tel.: (+27) 118014600  
Website: www.nilfisk.co.za

### SOUTH KOREA

Nilfisk Korea  
3F Duksoo B/D. 317-15  
Sungsoo-Dong 2Ga  
Sungdong-Gu, Seoul  
Tel.: (+82) 2497 8636  
Website: www.nilfisk.co.kr

### SPAIN

Nilfisk S.A.U  
Paseo del Rengle, 5 Planta. 9-10  
08302 Mataró  
Tel.: (+34) 93 741 2400  
Website: www.consumer.nilfisk.es

### SWEDEN

Nilfisk AB  
Täljegårdsgatan 4  
431 53 Mölndal  
Tel.: (+46) 31 706 73 00  
Website: www.consumer.nilfisk.se

### SWITZERLAND

Nilfisk AG  
Ringstrasse 19  
Kircheberg/Industri Stelz  
9500 Wil  
Tel.: (+41) 71 92 38 444  
Website: www.consumer.nilfisk.ch

### TAIWAN

Nilfisk Ltd  
Taiwan Branch (H.K)  
No. 5, Wan Fang Road  
Taipei  
Tel.: (+88) 6227 00 22 68  
Website: www.nilfisk.tw

### THAILAND

Nilfisk Co. Ltd.  
89 Soi Chokechai-Ruammitr  
Viphavadee-Rangsit Road  
Ladyao, Jatuchak, Bangkok 10900  
Tel.: (+66) 2275 5630  
Website: www.nilfisk.co.th

### TURKEY

Nilfisk A.S.  
Serifali Mh. Bayraktar Bulv. Sehit Sk. No:7  
Ümraniye, 34775 Istanbul  
Tel.: +90 216 466 94 94  
Website: www.consumer.nilfisk.com.tr

### UNITED ARAB EMIRATES

Nilfisk Middle East Branch  
SAIF-Zone  
P.O. Box 122298  
Sharjah  
Tel.: (+971) (0) 655-78813  
Website: www.nilfisk.com

### UNITED KINGDOM

Nilfisk Ltd.  
Nilfisk House, Bowerbank Way  
Gilwilly Industrial Estate, Penrith  
Cumbria CA11 9BQ  
Tel.: (+44) (0) 1768 868995  
Website: www.consumer.nilfisk.co.uk

### UNITED STATES

Nilfisk Inc.  
14600 21st Avenue North  
Plymouth, MN-55447  
Tel.: (+1) 800-989-2235  
Website: www.nilfisk.com

### VIETNAM

Nilfisk Vietnam  
No. 51 Doc Ngu Str.  
P. Vinh Phuc, Q.Ba Dinh  
Hanoi  
Tel.: (+84) 761 5642  
Website: www.nilfisk.com

