



















Neo - Istruzioni sull'uso















Istruzioni di sicurezza

-  Prima di utilizzare la macchina, leggere attentamente il presente manuale di istruzioni.
-  Conservare le istruzioni per un uso futuro.

Avvertenze !

-  Non utilizzare la macchina senza sacchetto raccogli-polvere e filtri.
-  La macchina non è destinata all'aspirazione di materiali o gas pericolosi poiché, in tal caso, può comportare gravi rischi per la salute delle persone.
-  La macchina non deve essere utilizzata per l'aspirazione di acqua o altri liquidi.
-  Non aspirare oggetti appuntiti come aghi o frammenti di vetro.
-  Non aspirare oggetti in fiamme o incandescenti come sigarette, fiammiferi o ceneri calde.
-  Utilizzare e conservare la macchina in interni e in un ambiente asciutto, a una temperatura compresa tra 0 °C e 60 °C.
-  Non utilizzare la macchina in esterni.
-  Quando si attiva il riavvolgimento automatico del cavo, è necessario prestare attenzione poiché la spina all'estremità del cavo elettrico può oscillare durante l'ultima parte del riavvolgimento.
-  Non utilizzare la macchina con le mani bagnate.
-  Spegnerla prima di scollegarla dall'alimentazione di rete.
-  Per scollegarla, tirare la spina, non il cavo. Non sollevare o tirare la macchina per il cavo.
-  Non utilizzare la macchina qualora il cavo presenti segni di danni. Verificare regolarmente che il cavo non sia danneggiato, in particolare se è stato schiacciato, calpestato o chiuso in una porta.
-  Non utilizzare la macchina in caso di guasto. Qualora sia caduta o danneggiata oppure sia rimasta all'aperto o esposta all'acqua, la macchina deve essere ispezionata da un centro di assistenza autorizzato.
-  Non manomettere o modificare i dispositivi di sicurezza meccanici o elettrici della macchina.
-  Tutte le riparazioni devono essere effettuate da un centro di assistenza autorizzato.
-  Utilizzare esclusivamente sacchetti raccogli-polvere, filtri e accessori originali forniti dal rivenditore di zona. L'utilizzo di sacchetti raccogli-polvere e filtri non originali invaliderà la garanzia.

-  Spegnerla e scollegare la macchina dall'alimentazione di rete prima di sostituire il sacchetto raccogli-polvere oppure il filtro. Tirare la spina, non il cavo.
-  Se il cavo di alimentazione è danneggiato, deve essere sostituito dal produttore, dal relativo centro di assistenza tecnica o da personale qualificato.
-  Non toccare con le mani i componenti rotanti quando si utilizza la spazzola turbo.
-  Questo apparecchio può essere utilizzato da bambini di età superiore agli 8 anni e da persone con limitate capacità fisiche, sensoriali o mentali o che non dispongono della necessaria esperienza, a condizione che l'uso avvenga sotto la supervisione di una persona responsabile o che vengano impartite loro istruzioni su come utilizzare l'apparecchio in modo sicuro e a condizione che essi comprendano i rischi che ne possono derivare.
-  Non permettere ai bambini di pulire l'apparecchio o di eseguire la manutenzione senza supervisione.
-  I bambini devono essere sorvegliati per assicurarsi che non giochino con l'apparecchio.
-  Non ricaricare le batterie non ricaricabili.
-  Prima di procedere alla carica, rimuovere le batterie ricaricabili.
-  Non utilizzare contemporaneamente batterie nuove e usate o tipi diversi di batterie.
-  Quando si inseriscono le batterie, assicurarsi che la polarità sia corretta.
-  Rimuovere le batterie scariche dall'apparecchio e smaltirle in modo sicuro.
-  Rimuovere le batterie se l'apparecchio viene riposto e non verrà utilizzato per un lungo periodo di tempo.
-  Non cortocircuitare i morsetti di alimentazione.

Assistenza e manutenzione

Conservare la macchina in interni e in un ambiente asciutto.

- Sostituire il prefiltro ogni quattro sacchetti raccogli-polvere cambiati.
- Pulire la superficie della macchina servendosi di panno asciutto oppure inumidito con un po' di detersivo.
- Ordinare gli accessori originali dal rivenditore di zona.
- Per assistenza, rivolgersi al rivenditore di zona.

Responsabilità

Nilfisk declina qualsiasi responsabilità per eventuali danni causati da utilizzo errato oppure modifiche apportate alla macchina. Per ulteriori istruzioni e informazioni sull'uso, fare riferimento al sito Web www.nilfisk.com.

WEEE



Il simbolo  indica che l'apparecchio non può essere smaltito con i rifiuti domestici, ma è necessario effettuare una raccolta separata. Smaltire i vecchi apparecchi presso il punto di raccolta appropriato per il riciclaggio.

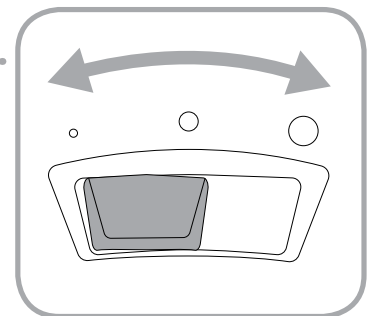
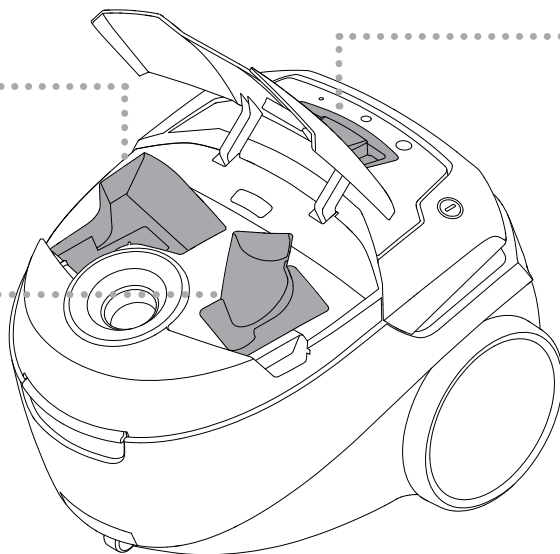
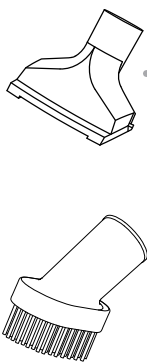
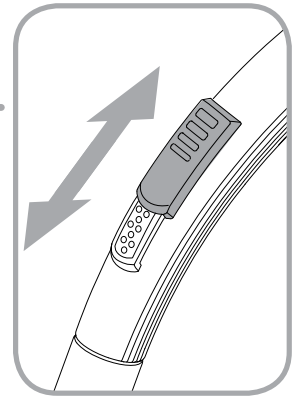
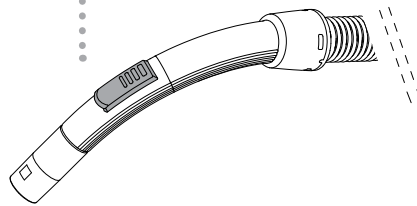
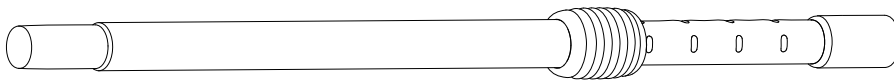
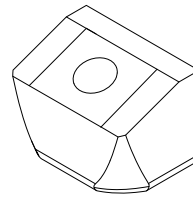
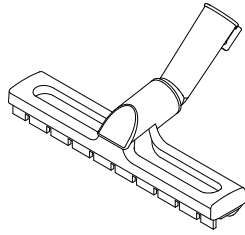
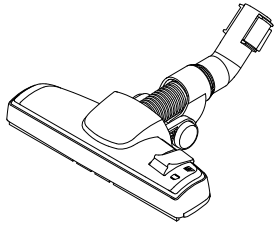

Il tipo di bocchette in dotazione può variare in base al modello.

A 

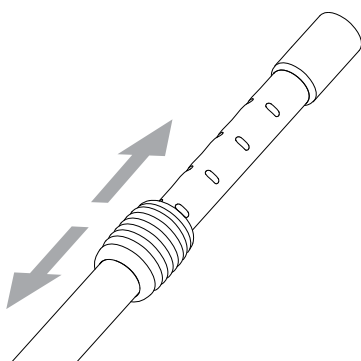
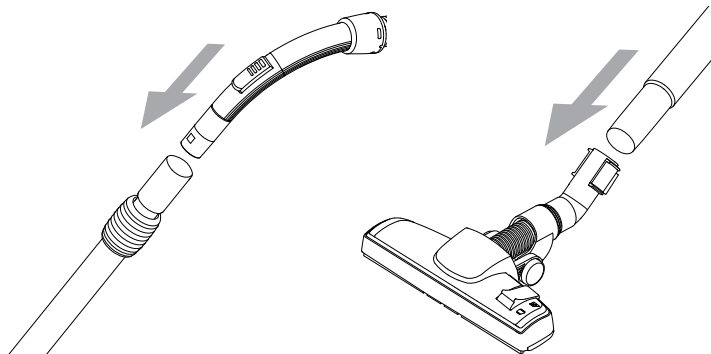
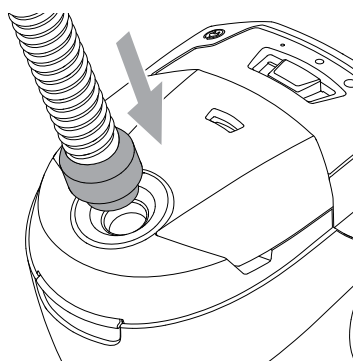

B 

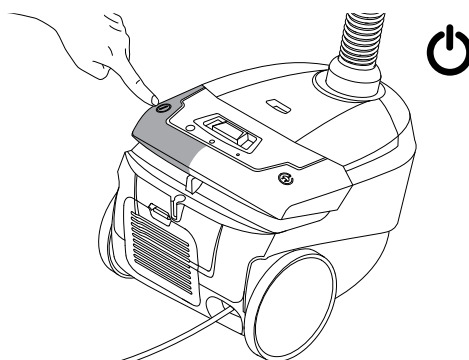
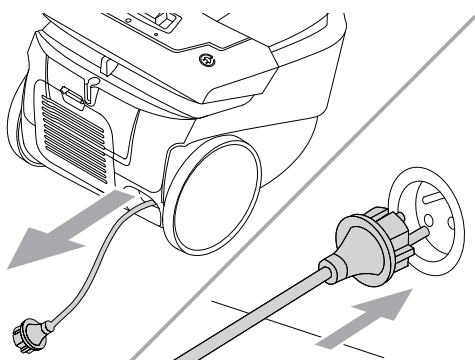

C 

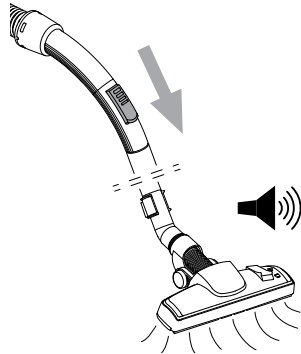
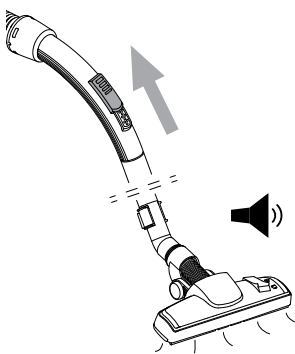
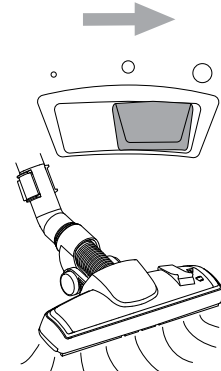
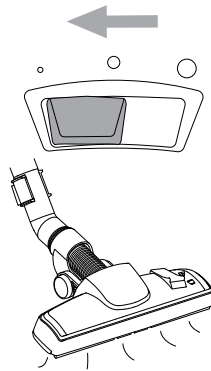
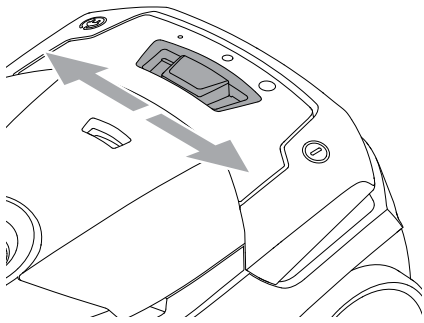

D 

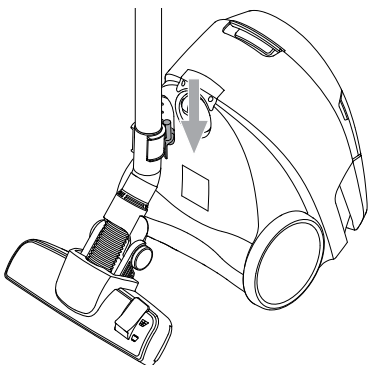
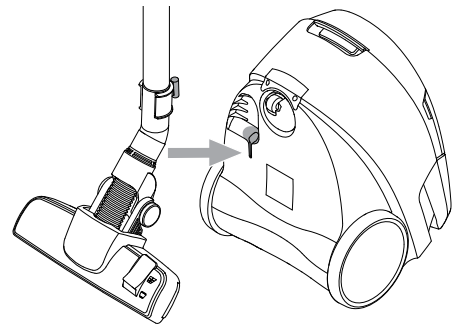
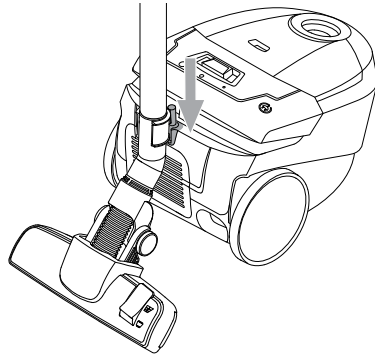
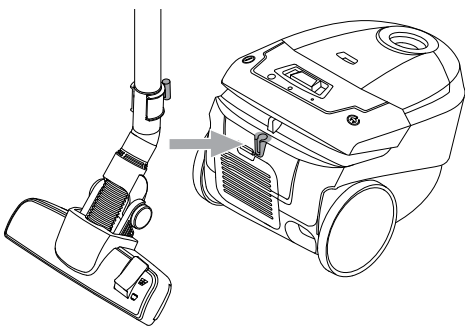

E

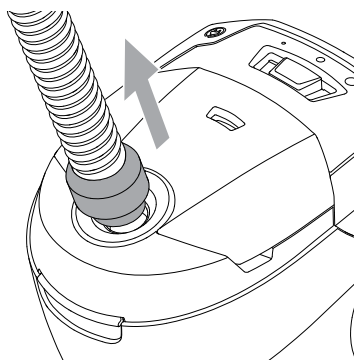
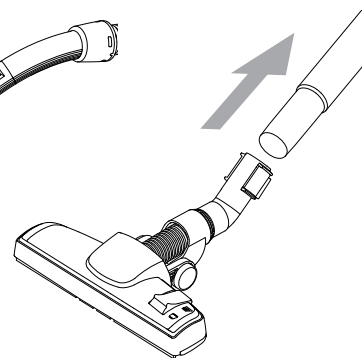
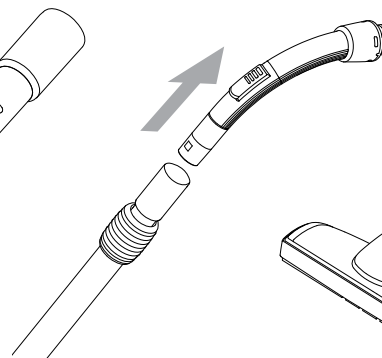
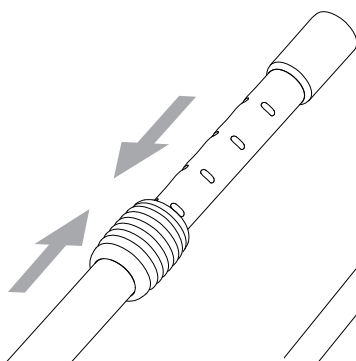
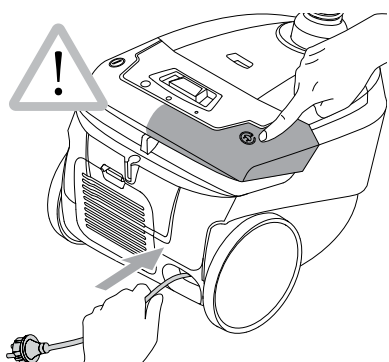
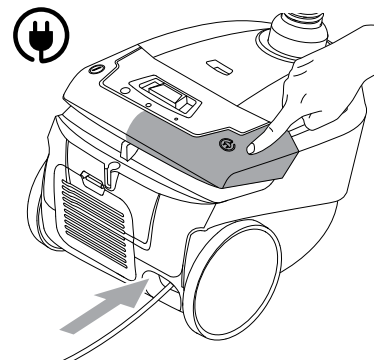
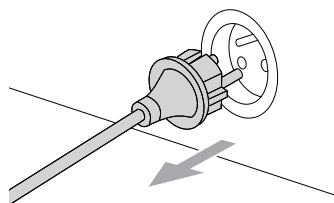
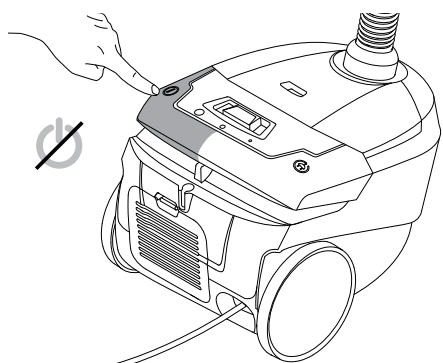

F

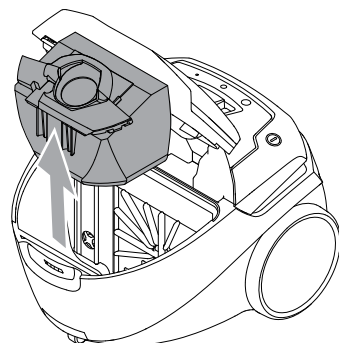
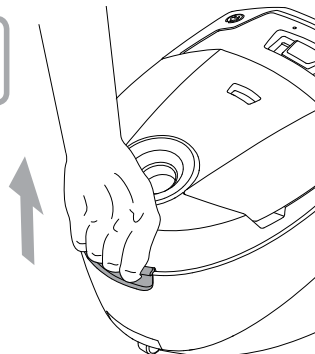
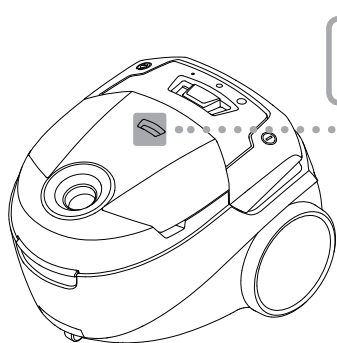
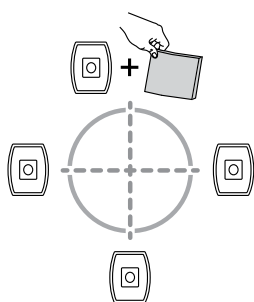

F

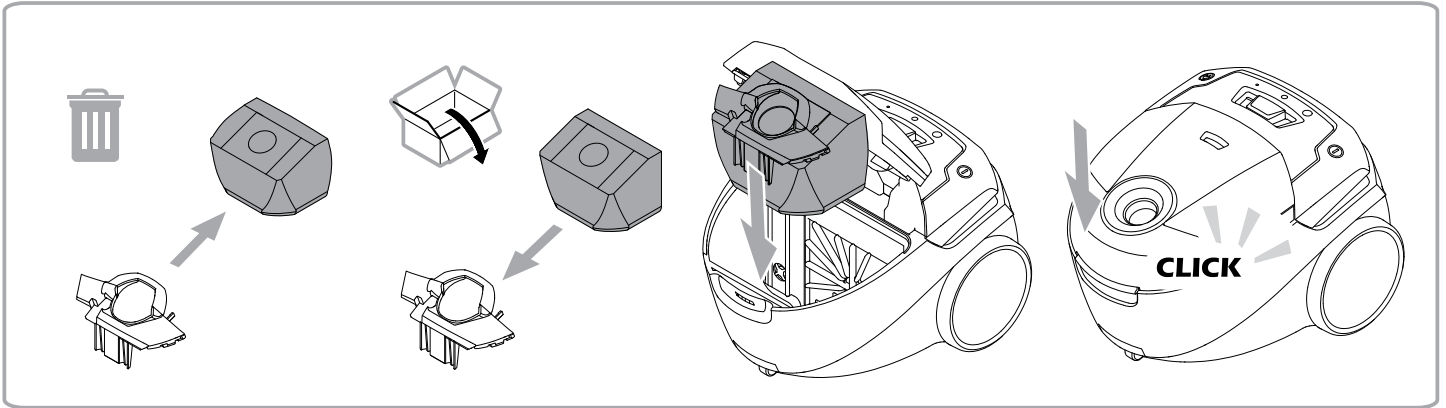

G

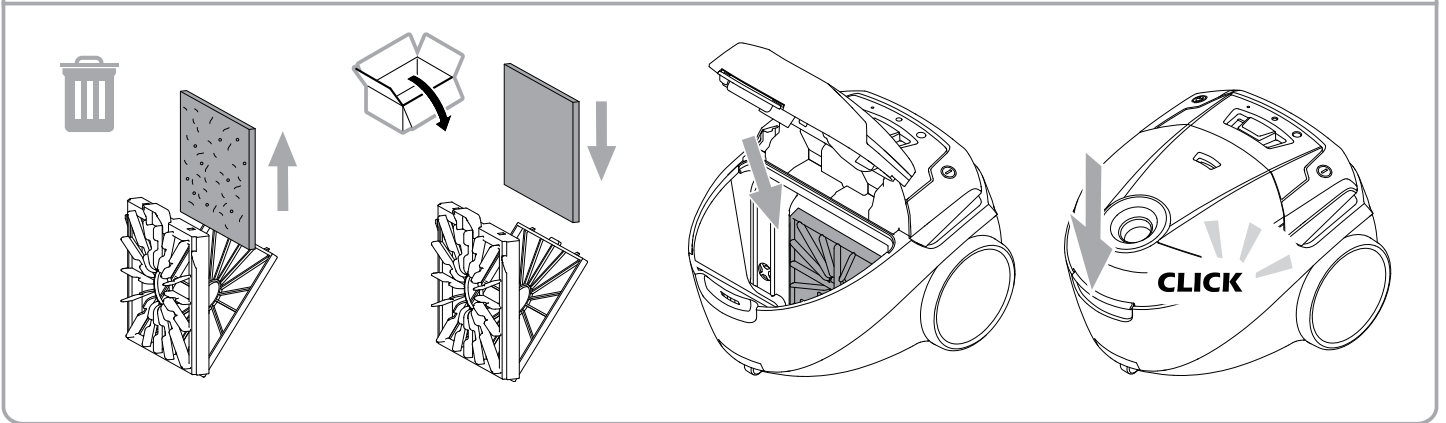
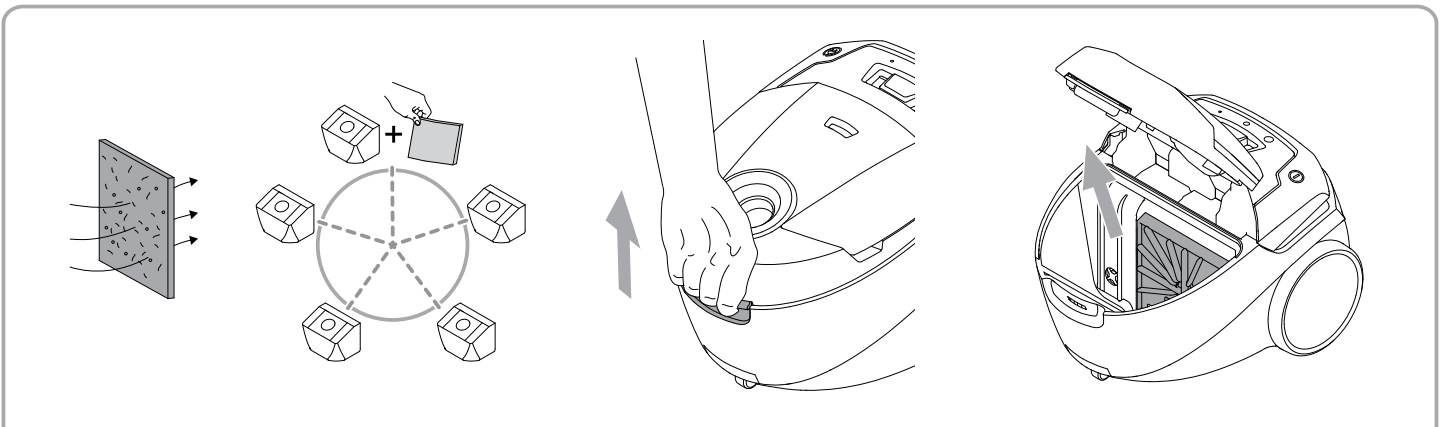

H

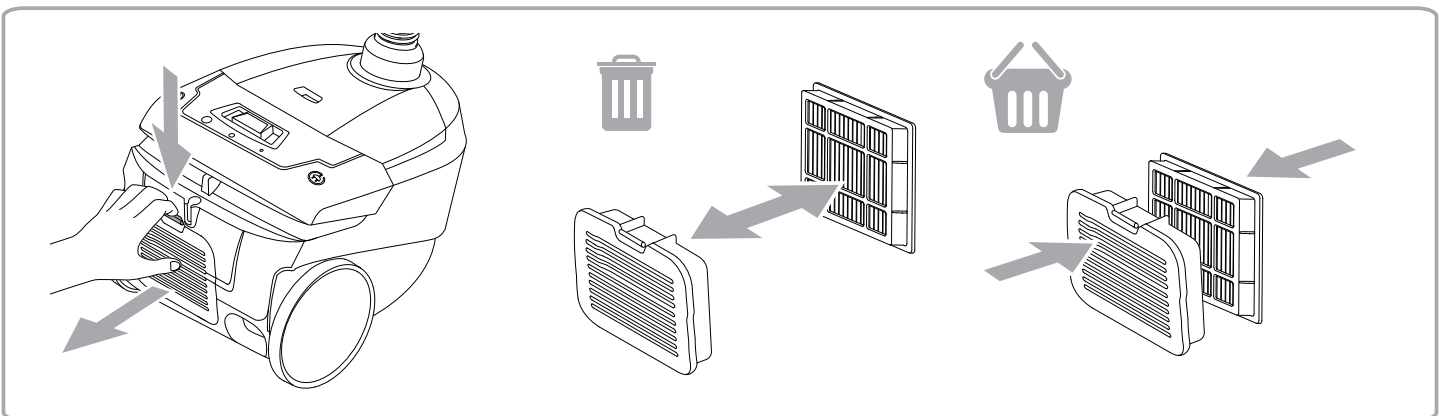

H

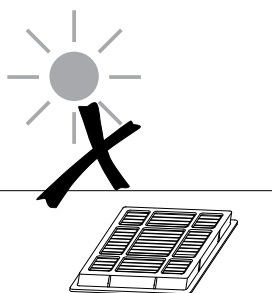
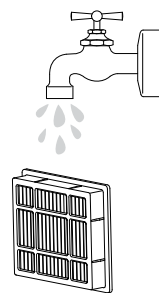
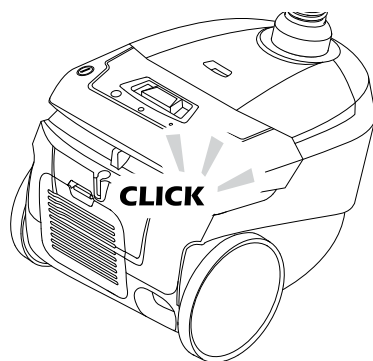
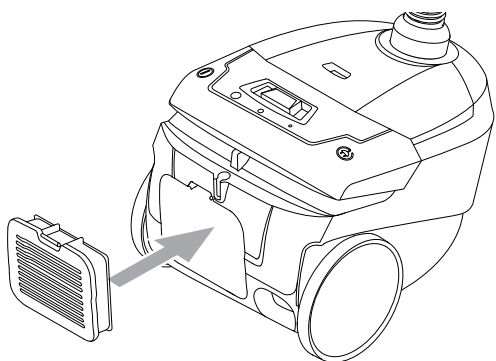

I

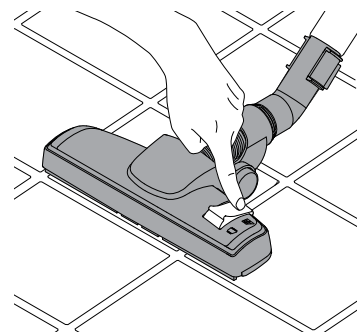
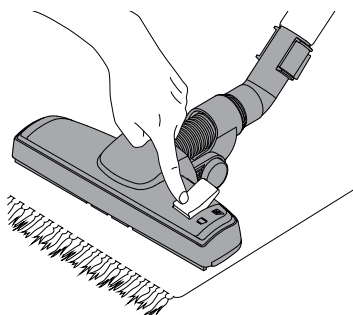
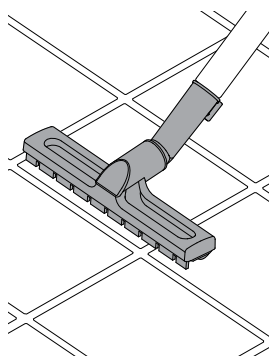
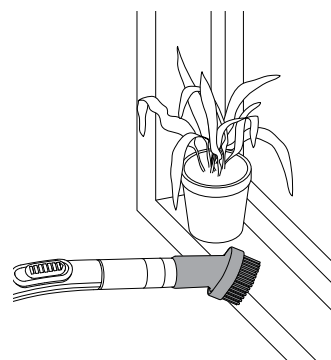
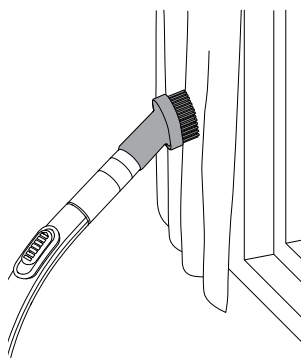
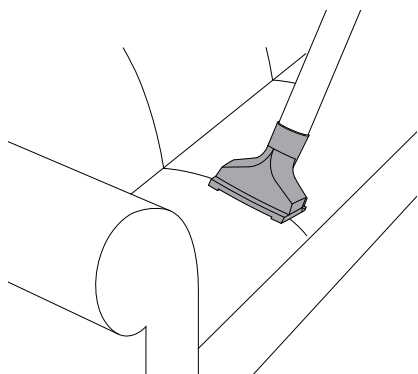

J

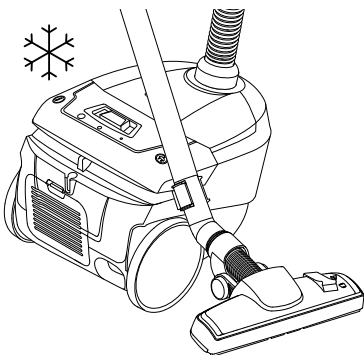
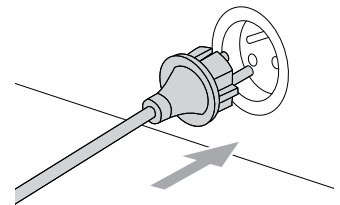
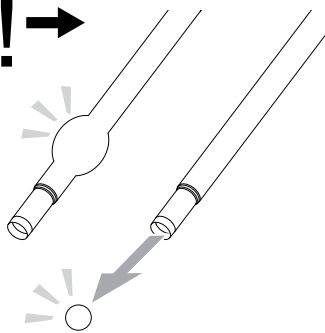
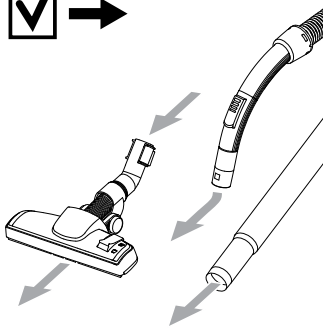
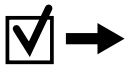
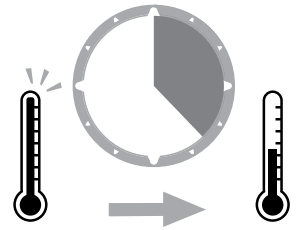
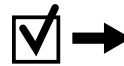
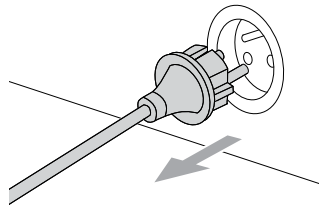
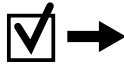
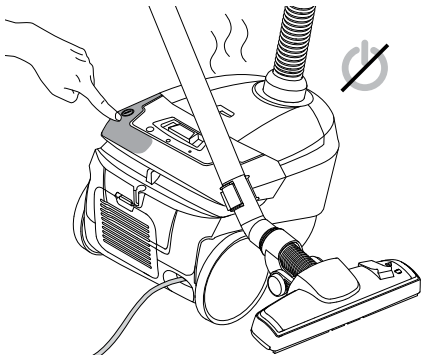

K

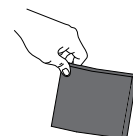
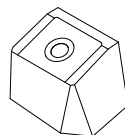
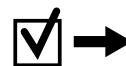
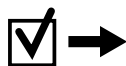
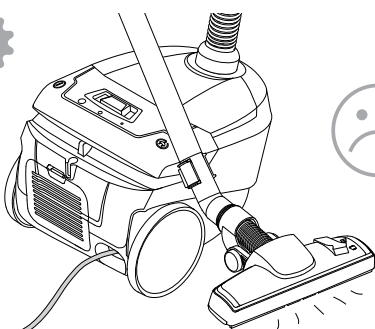

K

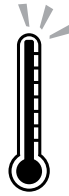
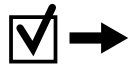
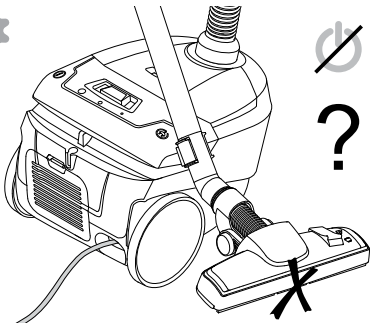
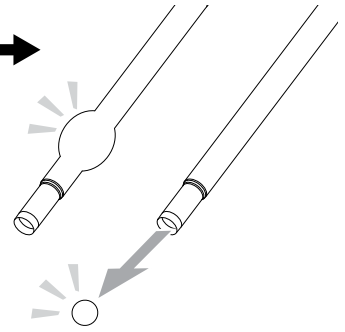
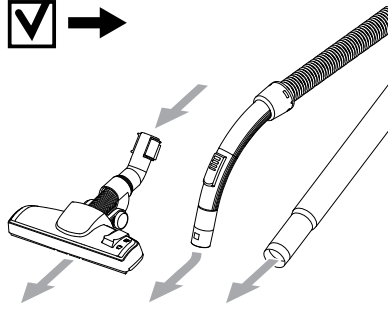
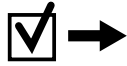
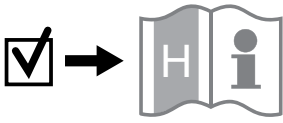

L

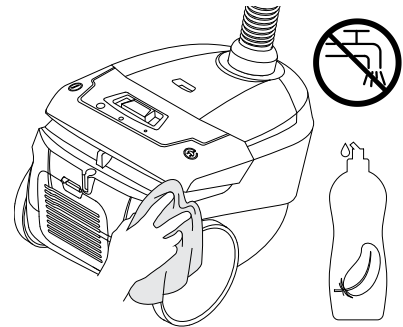
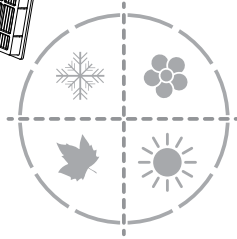
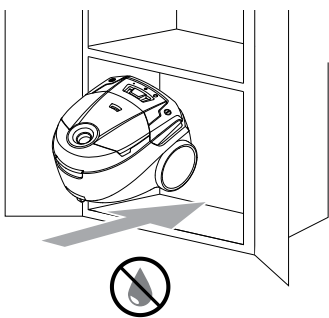

Dichiarazione di conformità

Nilfisk A/S
Kornmarksvej 1
DK-2605 Broendby
DENMARK

con la presente dichiara che il

Prodotto: Aspirapolvere alimentato secco
Descrizione: 220-240V 50/60Hz, IPX0
Tipo: Neo

è conforme ai seguenti standard:

EN 60335-1:2012+A11:2014
EN 60335-2-2:2010+A11:2012+A1:2013
EN 55014-1:2006+A1:2009+A2:2011
EN 55014-2:2015
EN 61000-3-2:2014
EN 61000-3-3:2013
EN 50581:2012
EN 60312-1:2017
EN 60704-2-1:2015

A seguito delle disposizioni:

2014/35/EU
2014/30/EU
2011/65/EU
2009/125/EC
666/2013/EU

Hadsund, 07-02-2018



Esben Graff
VP Portfolio Management, Consumer



HEAD QUARTER

DENMARK

Nilfisk A/S
Kornmarksvej 1
DK-2605 Broendby
Tel.: (+45) 4323 8100
Website: www.nilfisk.com

SALES COMPANIES

ARGENTINA

Nilfisk srl.
Edificio Central Park
Herrera 1855, 6th floor/604
Ciudad de Buenos Aires
Tel.: (+54) 11 6091 1571
Website: www.consumer.nilfisk.com.ar

AUSTRALIA

Nilfisk Pty Ltd
Unit 1/13 Bessemer Street
Blacktown NSW 2148
Tel.: (+61) 2 98348100
Website: www.consumer.nilfisk.com.au

AUSTRIA

Nilfisk GmbH
Metzgerstrasse 68
5101 Bergheim bei Salzburg
Tel.: (+43) 662 456 400 90
Website: www.nilfisk.at

BELGIUM

Nilfisk n.v.s.a.
Riverside Business Park
Boulevard Internationellaan 55
Bâtiment C3/C4 Gebouw
Bruxelles 1070
Tel.: (+32) 24 67 60 50
Website: www.consumer.nilfisk.be

Brazil

Nilfisk do Brasil
Av. Eng. Luis Carlos Berrini, 550
40 Andar, Sala 03
SP - 04571-000 Sao Paulo
Tel.: (+11) 3959-0300 / 3945-4744
Website: www.nilfisk.com.br

CANADA

Nilfisk Canada Company
240 Superior Boulevard
Mississauga, Ontario L5T 2L2
Tel.: (+1) 800-668-8400
Website: www.nilfisk.ca

CHILE

Nilfisk S.A. (Comercial KCS Ltda)
Salar de Llamara 822
8320000 Santiago
Tel.: (+56) 2684 5000
Website: www.nilfisk.cl

CHINA

Nilfisk
4189 Yindu Road
Xinzhuang Industrial Park
201108 Shanghai
Tel.: (+86) 21 3323 2000
Website: www.nilfisk.cn

CZECH REPUBLIC

Nilfisk s.r.o.
VGP Park Horní Počernice
Do Čertous 1/2658
193 00 Praha 9
Tel.: (+420) 244 090 912
Website: www.consumer.nilfisk.cz

DENMARK

Nilfisk A/S
Kornmarksvej 1
2605 Broendby
Tel.: (+45) 4323 4050
Website: www.consumer.nilfisk.dk

FINLAND

Nilfisk Oy Ab
Koskelontie 23 E
02920 Espoo
Tel.: (+358) 207 890 600
Website: www.consumer.nilfisk.fi

FRANCE

Nilfisk SAS
26 Avenue de la Baltique
Villebon sur Yvette
91978 Courtaubouef Cedex
Tel.: (+33) 169 59 87 24
Website: www.consumer.nilfisk.fr

GERMANY

Nilfisk GmbH
Guido-Oberdorfer-Strasse 2-10
89287 Bellenberg
Tel.: (+49) (0)7306/72-444
Website: www.consumer.nilfisk.de

GREECE

Nilfisk A.E.
Αναπαύσεως 29
Κορωπί Τ.Κ. 194 00

Tel.: (30) 210 9119 600
Website: www.consumer.nilfisk.gr

HOLLAND

Nilfisk B.V.
Versterkerstraat 5
1322 AN Almere
Tel.: (+31) 036 5460760
Website: www.consumer.nilfisk.nl

HONG KONG

Nilfisk Ltd.
2001 HK Worsted Mills
Industrial Building
31-39, Wo Tong Tsui St.
Kwai Chung, N.T.
Tel.: (+852) 2427 5951
Website: www.nilfisk.com

HUNGARY

Nilfisk Kft.
II. Rákóczi Ferenc út 10
2310 Szigetszentmiklós-Lakihegy
Tel.: (+36) 24 475 550
Website: www.nilfisk.hu

INDIA

Nilfisk India Limited
Pramukh Plaza, 'B' Wing, 4th floor, Unit No. 403
Cardinal Gracious Road, Chakala
Andheri (East) Mumbai 400 099
Tel.: (+91) 22 6118 8188
Website: www.nilfisk.in

IRELAND

Nilfisk
1 Stokes Place
St. Stephen's Green
Dublin 2
Tel.: (+35) 3 12 94 38 38
Website: www.nilfisk.ie

ITALY

Nilfisk SpA
Strada Comunale della Braglia, 18
26862 Guardamiglio (LO)
Tel.: (+39) (0) 377 414021
Website: www.nilfisk.it

JAPAN

Nilfisk Inc.
1-6-6 Kita-shinyokohama, Kouhoku-ku
Yokohama, 223-0059
Tel.: (+81) 45548 2571
Website: www.nilfisk.com

MALAYSIA

Nilfisk Sdn Bhd
Sd 33, Jalan KIP 10
Taman Perindustrian KIP
Sri Damansara
52200 Kuala Lumpur
Tel.: +603 6275 3120
Website: www.nilfisk.com

MEXICO

Nilfisk de Mexico, S. de R.L. de C.V.
Pirneos #515 Int.
60-70 Microparque
Industrial WSantiago
76120 Queretaro
Tel.: (+52) (442) 427 77 00
Website: www.nilfisk.com

NEW ZEALAND

Nilfisk Limited
Suite F, Building E
42 Tawa Drive
0632 Albany Auckland
Tel.: (+64) 9 414 1996
Website: www.nilfisk.com

NORWAY

Nilfisk AS
Bjørnerudveien 24
1266 Oslo
Tel.: (+47) 22 75 17 80
Website: www.consumer.nilfisk.no

PERU

Nilfisk S.A.C.
Calle Boulevard 162, Of. 703, Lima 33- Peru
Lima
Tel.: (511) 435-6840
Website: www.nilfisk.com

POLAND

Nilfisk Sp. Z.O.O.
Millenium Logistic Park
ul. 3 Maja 8, Bud. B4
05-800 Pruszków
Tel.: (+48) 22 738 3750
Website: www.consumer.nilfisk.pl

PORTUGAL

Nilfisk Lda.
Sintra Business Park
Zona Industrial Da Abrunheira
Edifício 1, 1º A
P2710-089 Sintra
Tel.: (+351) 21 911 2670
Website: www.nilfisk.pt

RUSSIA

Nilfisk LLC

Vyatskaya str. 27, bld. 7/1st
127015 Moscow
Tel.: (+7) 495 783 9602
Website: www.consumer.nilfisk.ru

SINGAPORE

Den-Sin
22 Tuas Avenue 2
639453 Singapore
Tel.: (+65) 6268 1006
Website: www.densin.com

SLOVAKIA

Nilfisk s.r.o.
Bancíkovej 1/A
SK-821 03 Bratislava
Tel.: (+421) 910 222 928
Website: www.consumer.nilfisk.sk

SOUTH AFRICA

Nilfisk (Pty) Ltd
Kimbutt Office Park, 9 Zeiss Road
Laser Park, Honeydew
Johannesburg
Tel.: (+27) 118014600
Website: www.nilfisk.co.za

SOUTH KOREA

Nilfisk Korea
3F Duksoo B/D. 317-15
Sungsoo-Dong 2Ga
Sungdong-Gu, Seoul
Tel.: (+82) 2497 8636
Website: www.nilfisk.co.kr

SPAIN

Nilfisk S.A.U
Paseo del Rengle, 5 Planta. 9-10
08302 Mataró
Tel.: (+34) 93 741 2400
Website: www.consumer.nilfisk.es

SWEDEN

Nilfisk AB
Talljägårdsgatan 4
431 53 Mölndal
Tel.: (+46) 31 706 73 00
Website: www.consumer.nilfisk.se

SWITZERLAND

Nilfisk AG
Ringstrasse 19
Kircheberg/Industri Stelz
9500 Wil
Tel.: (+41) 71 92 38 444
Website: www.consumer.nilfisk.ch

TAIWAN

Nilfisk Ltd
Taiwan Branch (H.K)
No. 5, Wan Fang Road
Taipei
Tel.: (+88) 6227 00 22 68
Website: www.nilfisk.tw

THAILAND

Nilfisk Co. Ltd.
89 Soi Chokechai-Ruammitr
Viphavadee-Rangsit Road
Ladyao, Jatuchak, Bangkok 10900
Tel.: (+66) 2275 5630
Website: www.nilfisk.co.th

TURKEY

Nilfisk A.S.
Serifali Mh. Bayraktar Bulv. Sehit Sk. No:7
Ümraniye, 34775 Istanbul
Tel.: +90 216 466 94 94
Website: www.consumer.nilfisk.com.tr

UNITED ARAB EMIRATES

Nilfisk Middle East Branch
SAIF-Zone
P.O. Box 122298
Sharjah
Tel.: (+971) (0) 655-78813
Website: www.nilfisk.com

UNITED KINGDOM

Nilfisk Ltd.
Nilfisk House, Bowerbank Way
Gilwilly Industrial Estate, Penrith
Cumbria CA11 9BQ
Tel.: (+44) (0) 1768 868995
Website: www.consumer.nilfisk.co.uk

UNITED STATES

Nilfisk Inc.
14600 21st Avenue North
Plymouth, MN-55447
Tel.: (+1) 800-989-2235
Website: www.nilfisk.com

VIETNAM

Nilfisk Vietnam
No. 51 Doc Ngu Str.
P. Vinh Phuc, Q.Ba Dinh
Hanoi
Tel.: (+84) 761 5642
Website: www.nilfisk.com

